

Operational Amplifiers

Ground Sense Operational Amplifiers

LM358xxx LM324xxx LM2904xxx LM2902xxx

General Description

LM358xxx and LM2904xxx series are dual ground sense operational amplifiers. LM324xxx and LM2902xxx series are quad. These have features of low current consumption and wide operating voltage range from 3V to 32V (single power supply).

Features

- Operable with a Single Power Supply
- Wide Operating Supply Voltage Range
- Input/output Ground Sense
- High Large Signal Voltage Gain

Applications

- Current Sense Application
- Buffer Application Amplifier
- Active Filter
- Consumer Electronics

Key Specifications

- Operating Supply Voltage (Single Supply): 3.0V to 32.0V
- Operating Temperature Range:
 - LM358xxx^{*1}: -40°C to +85°C
 - LM324xxx^{*1}: -40°C to +85°C
 - LM2904xxx^{*2}: -40°C to +125°C
 - LM2902xxx^{*2}: -40°C to +125°C
- Input Offset Voltage: 4.5mV (Max)
- Input Bias Current: 20nA (Typ)

Packages

Packages	W(Typ) x D(Typ) x H(Max)
SOP8 ^{*1}	5.00mm x 6.20mm x 1.71mm
SOP-J8 ^{*2}	4.90mm x 6.00mm x 1.65mm
SSOP-B8 ^{*1}	3.00mm x 6.40mm x 1.35mm
TSSOP-B8 ^{*2}	3.00mm x 6.40mm x 1.20mm
TSSOP-B8J ^{*1}	3.00mm x 4.90mm x 1.10mm
MSOP8 ^{*2}	2.90mm x 4.00mm x 0.90mm
SOP14 ^{*2}	8.70mm x 6.20mm x 1.71mm
SOP-J14 ^{*1}	8.65mm x 6.00mm x 1.65mm
SSOP-B14 ^{*2}	5.00mm x 6.40mm x 1.35mm
TSSOP-B14J ^{*1}	5.00mm x 6.40mm x 1.20mm

^{*1} Last Time Buy.
^{*2} Partial Last Time Buy.

Pin Configuration

- LM358F^{*1}, LM2904F^{*1} : SOP8
 LM358FJ^{*1}, LM2904FJ : SOP-J8
 LM358FV^{*1}, LM2904FV^{*1} : SSOP-B8
 LM358FVT^{*1}, LM2904FVT : TSSOP-B8
 LM358FVJ^{*1}, LM2904FVJ^{*1} : TSSOP-B8J
 LM358FVM^{*1}, LM2904FVM : MSOP8
- ^{*1} Last Time Buy.

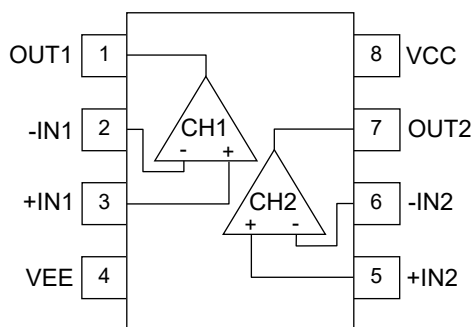

Pin No.	Pin Name
1	OUT1
2	-IN1
3	+IN1
4	VEE
5	+IN2
6	-IN2
7	OUT2
8	VCC

Pin Configuration – continued

LM324F^{*1}, LM2902F : SOP14
 LM324FJ^{*1}, LM2902FJ^{*1} : SOP-J14
 LM324FV^{*1}, LM2902FV : SSOP-B14
 LM324FVJ^{*1}, LM2902FVJ^{*1} : TSSOP-B14J
^{*1}Last Time Buy.

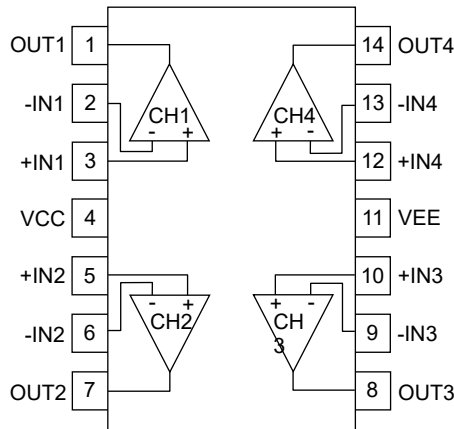

Pin No.	Pin Name
1	OUT1
2	-IN1
3	+IN1
4	VCC
5	+IN2
6	-IN2
7	OUT2
8	OUT3
9	-IN3
10	+IN3
11	VEE
12	+IN4
13	-IN4
14	OUT4

Absolute Maximum Ratings (T_A=25°C)

Parameter	Symbol	Rating				Unit		
		LM358xxx ^{*1}	LM324xxx ^{*1}	LM2904xxx ^{*2}	LM2902xxx ^{*2}			
Supply Voltage	V _{CC} -V _{EE}	36				V		
Power Dissipation	P _D	SOP8 ^{*1}	0.68 ^(Note 1,9)	-	0.68 ^(Note 1,9)	-	W	
		SOP-J8 ^{*2}	0.67 ^(Note 2,9)	-	0.67 ^(Note 2,9)	-		
		SSOP-B8 ^{*1}	0.62 ^(Note 3,9)	-	0.62 ^(Note 3,9)	-		
		TSSOP-B8 ^{*2}	0.62 ^(Note 3,9)	-	0.62 ^(Note 3,9)	-		
		TSSOP-B8J ^{*1}	0.58 ^(Note 4,9)	-	0.58 ^(Note 4,9)	-		
		MSOP8 ^{*2}	0.58 ^(Note 4,9)	-	0.58 ^(Note 4,9)	-		
		SOP14 ^{*2}	-	0.56 ^(Note 5,9)	-	0.56 ^(Note 5,9)		-
		SOP-J14 ^{*1}	-	1.02 ^(Note 6,9)	-	1.02 ^(Note 6,9)		-
		SSOP-B14 ^{*2}	-	0.87 ^(Note 7,9)	-	0.87 ^(Note 7,9)		-
		TSSOP-B14J ^{*1}	-	0.85 ^(Note 8,9)	-	0.85 ^(Note 8,9)		-
Differential Input Voltage ^(Note 10)	V _{ID}	36				V		
Input Common-mode Voltage Range	V _{ICM}	(V _{EE} -0.3) to (V _{EE} +36)				V		
Output Current ^(Note 11)	I _{OUT}	±40				mA		
Input Current ^(Note 12)	I _I	±10				mA		
Operating Supply Voltage	V _{opr}	3.0 to 32.0				V		
Operating Temperature Range	T _{opr}	-40 to +85		-40 to +125		°C		
Storage Temperature Range	T _{stg}	-55 to +150				°C		
Maximum Junction Temperature	T _{jmax}	150				°C		

^{*1}Last Time Buy.

^{*2}Partial Last Time Buy.

(Note 1) Reduce by 5.5mW per 1°C above 25°C.

(Note 2) Reduce by 5.4mW per 1°C above 25°C.

(Note 3) Reduce by 5.0mW per 1°C above 25°C.

(Note 4) Reduce by 4.7mW per 1°C above 25°C.

(Note 5) Reduce by 4.5mW per 1°C above 25°C.

(Note 6) Reduce by 8.2mW per 1°C above 25°C.

(Note 7) Reduce by 7.0mW per 1°C above 25°C.

(Note 8) Reduce by 6.8mW per 1°C above 25°C.

(Note 9) Mounted on an FR4 glass epoxy PCB 70mm×70mm×1.6mm (Copper foil area less than 3%).

(Note 10) Differential Input Voltage is the voltage difference between the inverting and non-inverting inputs. The input pin voltage is set to more than V_{EE}.

(Note 11) The excessive heat generation may occur due to the short-circuit from the output pin to the power supply pin. Do not use the output pin short to power supply. Use the output current less than 40 mA regardless of the power supply voltage.

(Note 12) An excessive input current will flow when input voltages of less than V_{EE}-0.6V are applied.

The input current can be set to less than the rated current by adding a limiting resistor.

Caution: Operating the IC over the absolute maximum ratings may damage the IC. The damage can either be a short circuit between pins or an open circuit between pins and the internal circuitry. Therefore, it is important to consider circuit protection measures, such as adding a fuse, in case the IC is operated over the absolute maximum ratings.

Electrical Characteristics

OLM358xxx^{*1}, LM2904xxx^{*2} (Unless otherwise specified V_{CC}=+5V, V_{EE}=0V)

Parameter	Symbol	Temperature Range	Limits			Unit	Condition
			Min	Typ	Max		
Input Offset Voltage ^(Note 13,14)	V _{IO}	25°C	-	1	4.5	mV	V _{OUT} =1.4V
		Full Range	-	-	5		V _{CC} =5 to 30V, V _{OUT} =1.4V
Input Offset Voltage Drift ^(Note 13)	ΔV _{IO} /ΔT	-	-	6	-	μV/°C	V _{OUT} =1.4V
Input Offset Current ^(Note 13,14)	I _{IO}	25°C	-	2	50	nA	V _{OUT} =1.4V
		Full Range	-	-	200		
Input Bias Current ^(Note 13,14)	I _B	25°C	-	20	250	nA	V _{OUT} =1.4V
		Full Range	-	-	300		
Supply Current ^(Note 14)	I _{CC}	25°C	-	0.6	1.2	mA	R _L =∞, All Op-Amps
		Full Range	-	-	1.5		
Maximum Output Voltage (High) ^(Note 14)	V _{OH}	25°C	3.5	-	-	V	R _L =2kΩ
		Full Range	27	28	-		V _{CC} =30V, R _L =10kΩ
Maximum Output Voltage (Low) ^(Note 14)	V _{OL}	Full Range	-	5	20	mV	R _L =∞
Large Signal Voltage Gain	A _v	25°C	25	100	-	V/mV	R _L ≥2kΩ, V _{CC} =15V V _{OUT} =1.4 to 11.4V
			88	100	-		
Input Common-mode Voltage Range	V _{ICM}	25°C	0	-	3.5	V	V _{ICM} =V _{EE} to (V _{CC} -1.5V) V _{OUT} =1.4V
Input Common-mode Voltage Range (VEE side) ^(Note 15)	V _{ICM}	Full Range	-	0.1	-	V	V _{OUT} =1.4V
Common-mode Rejection Ratio	CMRR	25°C	70	80	-	dB	V _{OUT} =1.4V
Power Supply Rejection Ratio	PSRR	25°C	65	100	-	dB	V _{CC} =5 to 30V
Output Source Current ^(Note 14,16)	I _{SOURCE}	25°C	20	30	40	mA	V _{+IN} =1V, V _{-IN} =0V V _{OUT} =0V, Short Current
		Full Range	10	-	-		
Output Sink Current ^(Note 14,16)	I _{SINK}	25°C	20	27	40	mA	V _{+IN} =0V, V _{-IN} =1V V _{OUT} =5V, Short Current
		Full Range	5	-	-		
		25°C	20	50	-	μA	V _{+IN} =0V, V _{-IN} =1V V _{OUT} =200mV
Channel Separation	CS	25°C	-	120	-	dB	f=1kHz, Input Referred
Slew Rate	SR	25°C	-	0.3	-	V/μs	V _{CC} =15V, A _v =0dB R _L =2kΩ, C _L =100pF
Gain Bandwidth	GBW	25°C	-	0.8	-	MHz	V _{CC} =15V, V _{EE} =-15V R _L =2kΩ, C _L =100pF
Phase Margin	θ	25°C	-	80	-	deg	A _v =40dB
Input Referred Noise Voltage	V _N	25°C	-	40	-	nV/√Hz	V _{CC} =15V, V _{EE} =-15V R _S =100Ω, V _{IN} =0V, f=1kHz

*1 Last Time Buy.

*2 Partial Last Time Buy.

(Note 13) Absolute value

(Note 14) LM358xxx Full Range: T_A=-40°C to +85°C, LM2904xxx Full Range: T_A=-40°C to +125°C

(Note 15) LM2904xxx only.

(Note 16) Consider the power dissipation of the IC under high temperature when selecting the output current value.

There may be a case where the output current value is reduced due to the rise in IC temperature caused by the heat generated inside the IC.

Electrical Characteristics - continued

OLM324xxx^{*1}, LM2902xxx^{*2} (Unless otherwise specified V_{CC}=+5V, V_{EE}=0V)

Parameter	Symbol	Temperature Range	Limits			Unit	Condition
			Min	Typ	Max		
Input Offset Voltage ^(Note 17,18)	V _{IO}	25°C	-	1	4.5	mV	V _{OUT} =1.4V
		Full Range	-	-	5		V _{CC} =5 to 30V, V _{OUT} =1.4V
Input Offset Voltage Drift ^(Note 18)	ΔV _{IO} /ΔT	-	-	6	-	μV/°C	V _{OUT} =1.4V
Input Offset Current ^(Note 17,18)	I _{IO}	25°C	-	2	50	nA	V _{OUT} =1.4V
		Full Range	-	-	200		
Input Bias Current ^(Note 17,18)	I _B	25°C	-	20	250	nA	V _{OUT} =1.4V
		Full Range	-	-	300		
Supply Current ^(Note 18)	I _{CC}	25°C	-	1	2	mA	R _L =∞, All Op-Amps
		Full Range	-	-	2.5		
Maximum Output Voltage (High) ^(Note 18)	V _{OH}	25°C	3.5	-	-	V	R _L =2kΩ
		Full Range	27	28	-		V _{CC} =30V, R _L =10kΩ
Maximum Output Voltage (Low) ^(Note 18)	V _{OL}	Full Range	-	5	20	mV	R _L =∞
Large Signal Voltage Gain	A _v	25°C	25	100	-	V/mV	R _L ≥2kΩ, V _{CC} =15V V _{OUT} =1.4 to 11.4V
			88	100	-		
Input Common-mode Voltage Range	V _{ICM}	25°C	0	-	3.5	V	V _{ICM} =V _{EE} to (V _{CC} -1.5V) V _{OUT} =1.4V
Input Common-mode Voltage Range (VEE side) ^(Note 19)	V _{ICM}	Full Range	-	0.1	-	V	V _{OUT} =1.4V
Common-mode Rejection Ratio	CMRR	25°C	70	80	-	dB	V _{OUT} =1.4V
Power Supply Rejection Ratio	PSRR	25°C	65	100	-	dB	V _{CC} =5 to 30V
Output Source Current ^(Note 18,20)	I _{SOURCE}	25°C	20	30	40	mA	V _{+IN} =1V, V _{-IN} =0V V _{OUT} =0V, Short Current
		Full Range	10	-	-		
Output Sink Current ^(Note 18,20)	I _{SINK}	25°C	20	27	40	mA	V _{+IN} =0V, V _{-IN} =1V V _{OUT} =5V, Short Current
		Full Range	5	-	-		
		25°C	20	50	-	μA	V _{+IN} =0V, V _{-IN} =1V V _{OUT} =200mV
Channel Separation	CS	25°C	-	120	-	dB	f=1kHz, Input Referred
Slew Rate	SR	25°C	-	0.3	-	V/μs	V _{CC} =15V, A _v =0dB R _L =2kΩ, C _L =100pF
Gain Bandwidth	GBW	25°C	-	0.8	-	MHz	V _{CC} =15V, V _{EE} =-15V R _L =2kΩ, C _L =100pF
Phase Margin	θ	25°C	-	80	-	deg	A _v =40dB
Input Referred Noise Voltage	V _N	25°C	-	40	-	nV/√Hz	V _{CC} =15V, V _{EE} =-15V R _S =100Ω, V _{IN} =0V, f=1kHz

*1 Last Time Buy.

*2 Partial Last Time Buy.

(Note 17) Absolute value

(Note 18) LM324xxx Full Range: T_A=-40°C to +85°C, LM2902xxx Full Range: T_A=-40°C to +125°C

(Note 19) LM2902xxx only.

(Note 20) Consider the power dissipation of the IC under high temperature when selecting the output current value.

There may be a case where the output current value is reduced due to the rise in IC temperature caused by the heat generated inside the IC.

Description of Electrical Characteristics

Below are the descriptions of the relevant electrical terms used in this datasheet. Items and symbols used are also shown. Note that item names, symbols, and their meanings may differ from those of another manufacturer's document or general document.

1. Absolute Maximum Ratings

Absolute maximum rating items indicate the conditions which must not be exceeded. Application of voltage in excess of the absolute maximum rating or use out of absolute maximum rated temperature environment may cause deterioration of electrical characteristics.

- (1) Supply Voltage (V_{CC}/V_{EE})
Indicates the maximum voltage that can be applied between the VCC pin and VEE pin without deterioration of characteristics of internal circuit.
- (2) Differential Input Voltage (V_{ID})
Indicates the maximum voltage that can be applied between the non-inverting and inverting pins without damaging the IC.
- (3) Input Common-mode Voltage Range (V_{ICM})
Indicates the maximum voltage that can be applied to the non-inverting and inverting pins without deterioration or destruction of electrical characteristics. Input common-mode voltage range of the maximum ratings does not assure normal operation of IC. For normal operation, use the IC within the input common-mode voltage range characteristics.
- (4) Power Dissipation (P_D)
Indicates the power that can be consumed by the IC when mounted on a specific board at the ambient temperature 25°C (normal temperature). As for package product, P_D is determined by the temperature that can be permitted by the IC in the package (maximum junction temperature) and the thermal resistance of the package.

2. Electrical Characteristics

- (1) Input Offset Voltage (V_{IO})
Indicates the voltage difference between non-inverting pin and inverting pin. It can be translated to the input voltage difference required for setting the output voltage to 0V.
- (2) Input Offset Voltage Drift ($\Delta V_{IO}/\Delta T$)
Denotes the ratio of the input offset voltage fluctuation to the ambient temperature fluctuation.
- (3) Input Offset Current (I_{IO})
Indicates the difference of input bias current between the non-inverting and inverting pins.
- (4) Input Bias Current (I_B)
Indicates the current that flows into or out of the input pin. It is defined by the average of input bias currents at the non-inverting and inverting pins.
- (5) Supply Current (I_{CC})
Indicates the current that flows within the IC under specified no-load conditions.
- (6) Maximum Output Voltage (High) / Maximum Output Voltage (Low) (V_{OH}/V_{OL})
Indicates the voltage range of the output under specified load condition. It is typically divided into maximum output voltage high and low. Maximum output voltage high indicates the upper limit of output voltage. Maximum output voltage low indicates the lower limit.
- (7) Large Signal Voltage Gain (A_V)
Indicates the amplification rate (gain) of output voltage against the voltage difference between non-inverting pin and inverting pin. It is normally the amplification rate (gain) with reference to DC voltage.
 $A_V = (\text{Output Voltage}) / (\text{Differential Input Voltage})$
- (8) Input Common-mode Voltage Range (V_{ICM})
Indicates the input voltage range at which IC normally operates.
- (9) Common-mode Rejection Ratio (CMRR)
Indicates the ratio of fluctuation of input offset voltage when the input common-mode voltage is changed. It is normally the fluctuation of DC.
 $CMRR = (\text{Change of Input Common-mode Voltage}) / (\text{Input Offset Fluctuation})$

- (10) Power Supply Rejection Ratio (PSRR)
Indicates the ratio of fluctuation of input offset voltage when supply voltage is changed.
It is normally the fluctuation of DC.
 $PSRR = (\text{Change of Power Supply Voltage}) / (\text{Input Offset Fluctuation})$
- (11) Output Source Current/ Output Sink Current (I_{SOURCE} / I_{SINK})
The maximum current that the IC can output under specific output conditions. The output source current indicates the current flowing out from the IC, and the output sink current indicates the current flowing into the IC.
- (12) Channel Separation (CS)
Indicates the fluctuation in the output voltage of the driven channel with reference to the change of output voltage of the channel which is not driven.
- (13) Slew Rate (SR)
Indicates the rate of the change of the output voltage with time when a step input signal is applied.
- (14) Gain Bandwidth (GBW)
The product of the open-loop voltage gain and the frequency at which the voltage gain decreases 6dB/octave.
- (15) Phase Margin (θ)
Indicates the margin of phase from 180 degree phase lag at unity gain frequency.
- (16) Input Referred Noise Voltage (V_N)
Indicates a noise voltage generated inside the operational amplifier equivalent by ideal voltage source connected in series with input pin.

Typical Performance Curves

OLM358xxx^{*1}, LM2904xxx^{*2}

^{*1}Last Time Buy.

^{*2}Partial Last Time Buy.

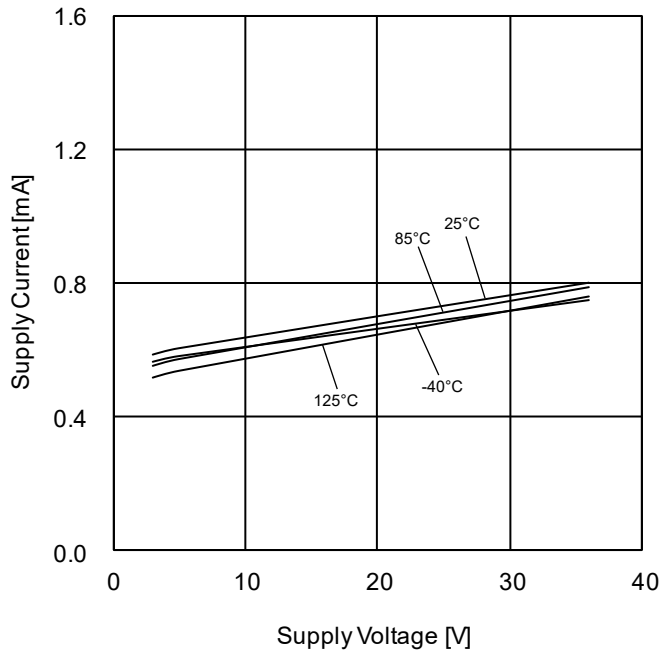

Figure 1. Supply Current vs Supply Voltage

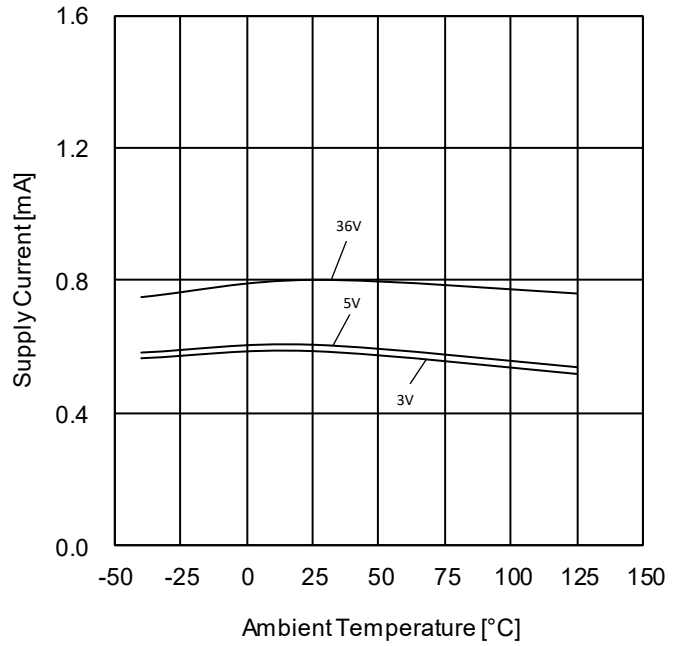

Figure 2. Supply Current vs Ambient Temperature

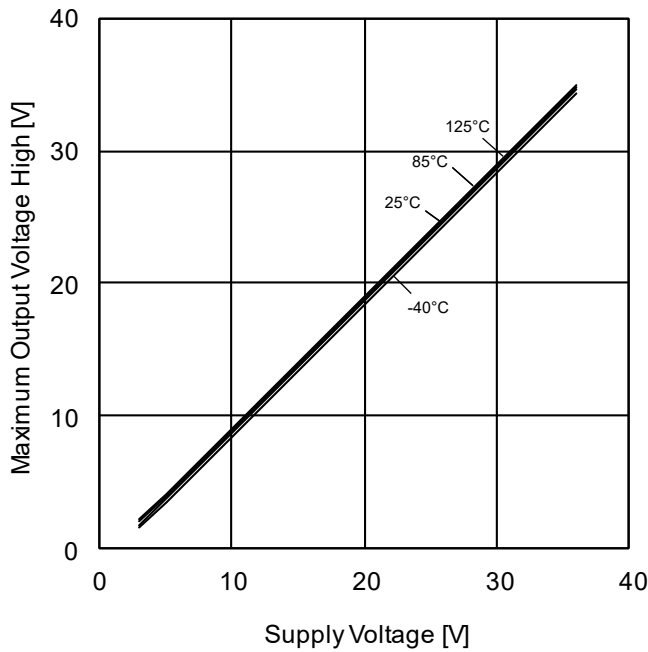

Figure 3. Maximum Output Voltage (High) vs Supply Voltage (RL=10kΩ)

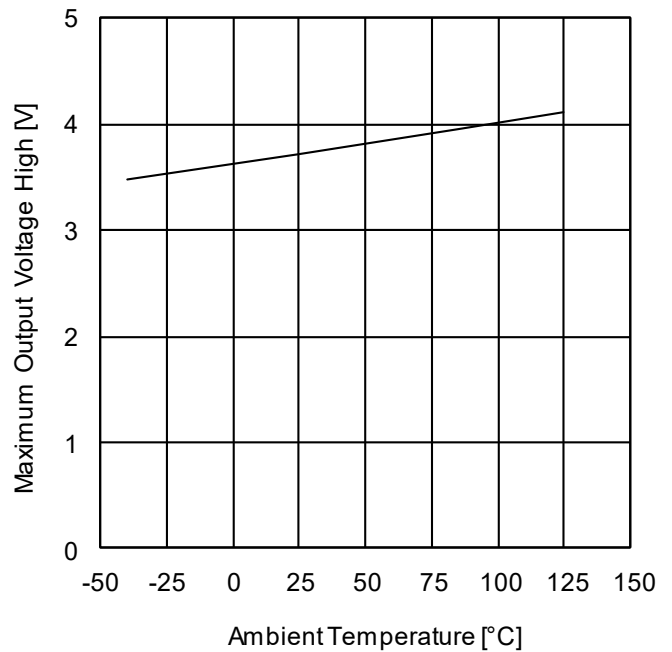

Figure 4. Maximum Output Voltage (High) vs Ambient Temperature (Vcc=5V, RL=10kΩ)

(*) The above data are measurement value of typical sample, they are not guaranteed.
 LM358xxx: -40°C to +85°C LM2904xxx: -40°C to 125°C

Typical Performance Curves - continued

OLM358xxx^{*1}, LM2904xxx^{*2}

^{*1}Last Time Buy.

^{*2}Partial Last Time Buy.

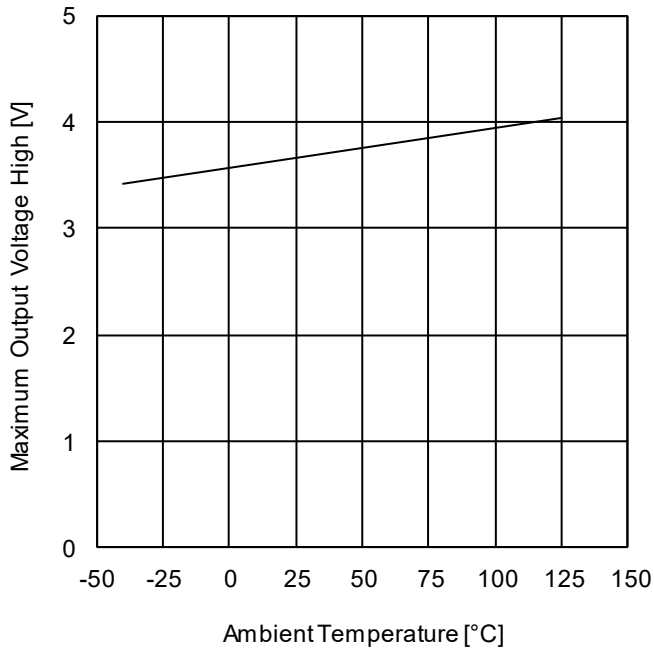

Figure 5. Maximum Output Voltage (High) vs Ambient Temperature ($V_{CC}=5V$, $R_L=2k\Omega$)

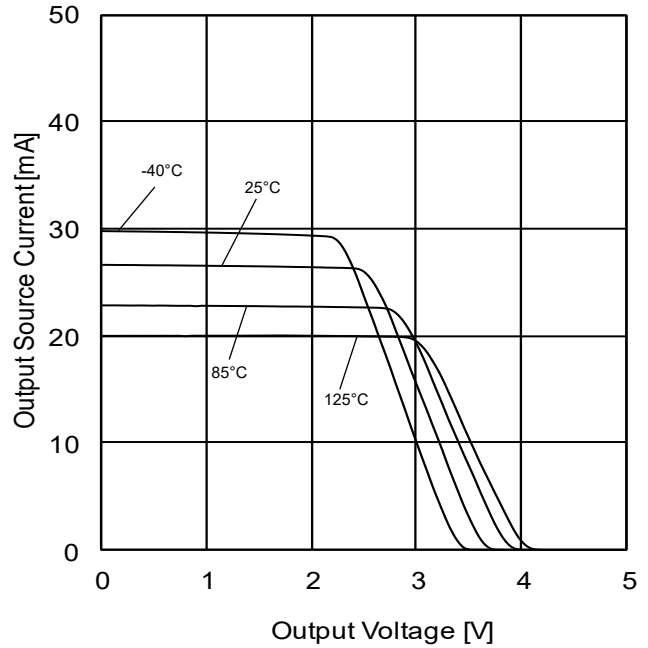

Figure 6. Output Source Current vs Output Voltage ($V_{CC}=5V$)

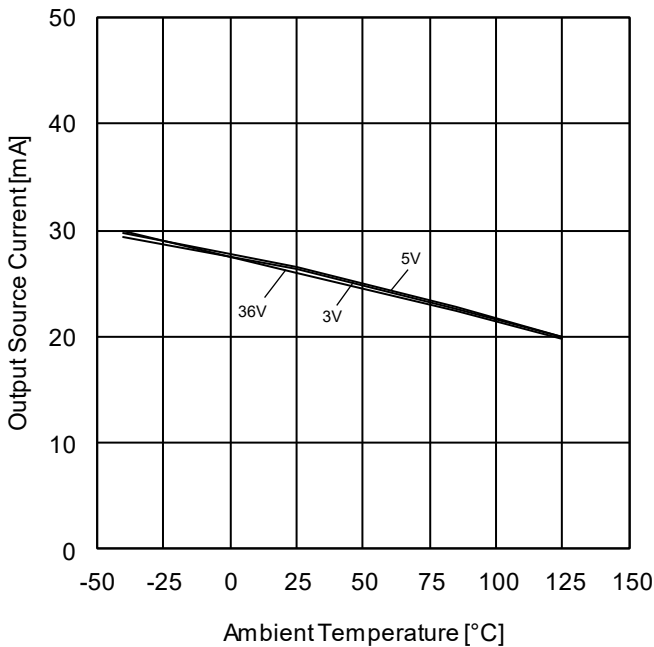

Figure 7. Output Source Current vs Ambient Temperature ($V_{OUT}=0V$)

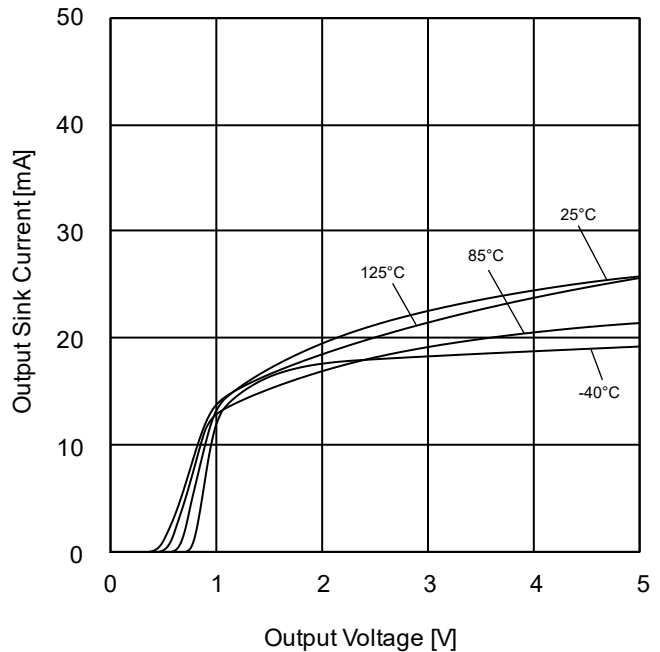

Figure 8. Output Sink Current vs Output Voltage ($V_{CC}=5V$)

(*) The above data are measurement value of typical sample, they are not guaranteed.
 LM358xxx: -40°C to +85°C LM2904xxx: -40°C to 125°C

Typical Performance Curves - continued

OLM358xxx^{*1}, LM2904xxx^{*2}

^{*1}Last Time Buy.

^{*2}Partial Last Time Buy.

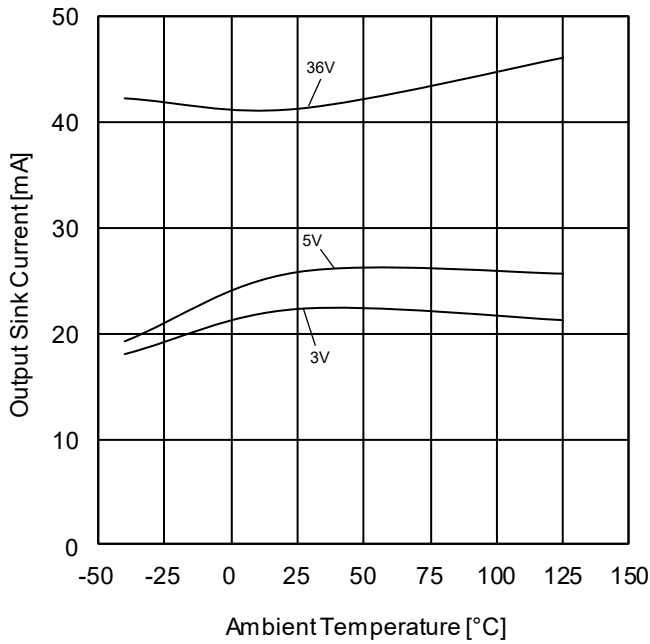

Figure 9. Output Sink Current vs Ambient Temperature ($V_{OUT}=V_{CC}$)

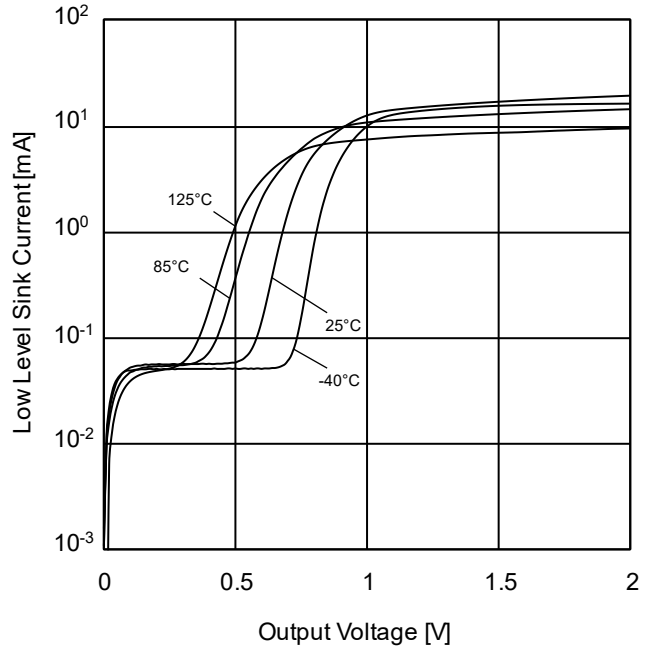

Figure 10. Low Level Sink Current vs Output Voltage ($V_{CC}=5V$)

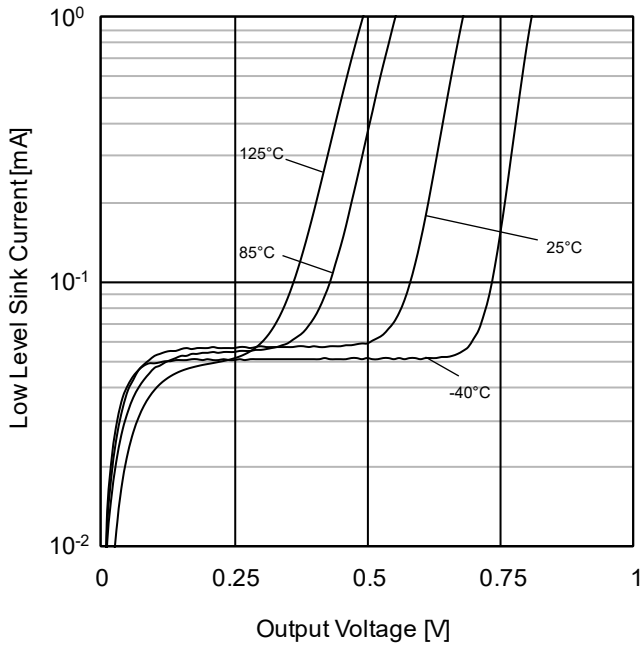

Figure 11. Low Level Sink Current vs Output Voltage (Enlarged view) ($V_{CC}=5V$)

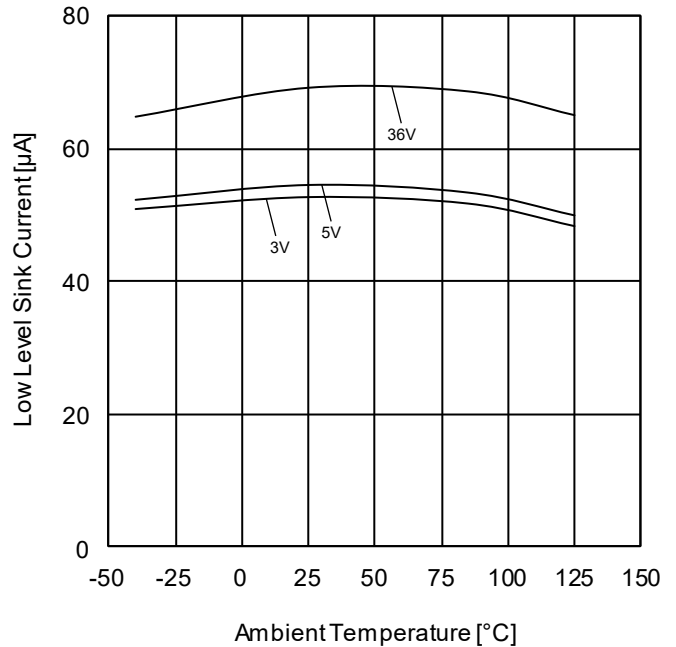

Figure 12. Low Level Sink Current vs Ambient Temperature ($V_{OUT}=200mV$)

(*) The above data are measurement value of typical sample, they are not guaranteed.
 LM358xxx: -40°C to +85°C LM2904xxx: -40°C to 125°C

Typical Performance Curves - continued

OLM358xxx^{*1}, LM2904xxx^{*2}

^{*1}Last Time Buy.

^{*2}Partial Last Time Buy.

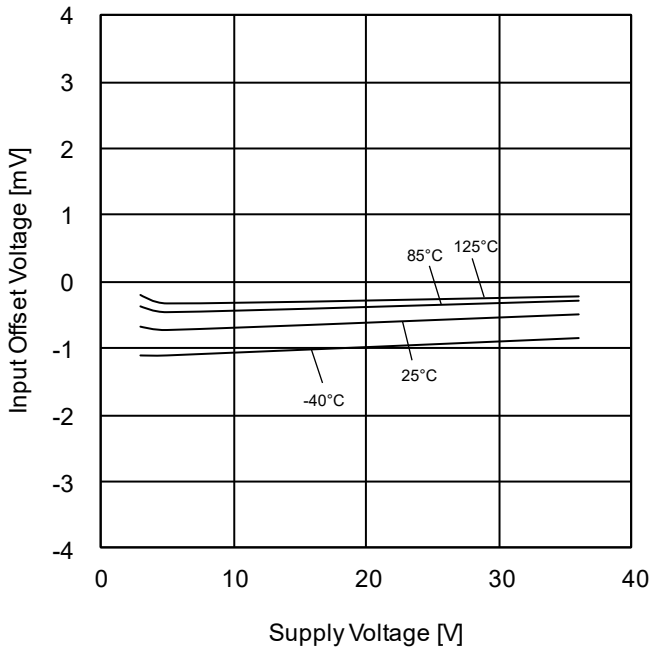

Figure 13. Input Offset Voltage vs Supply Voltage ($V_{ICM}=V_{CC}/2$, $E_K=-V_{CC}/2$)

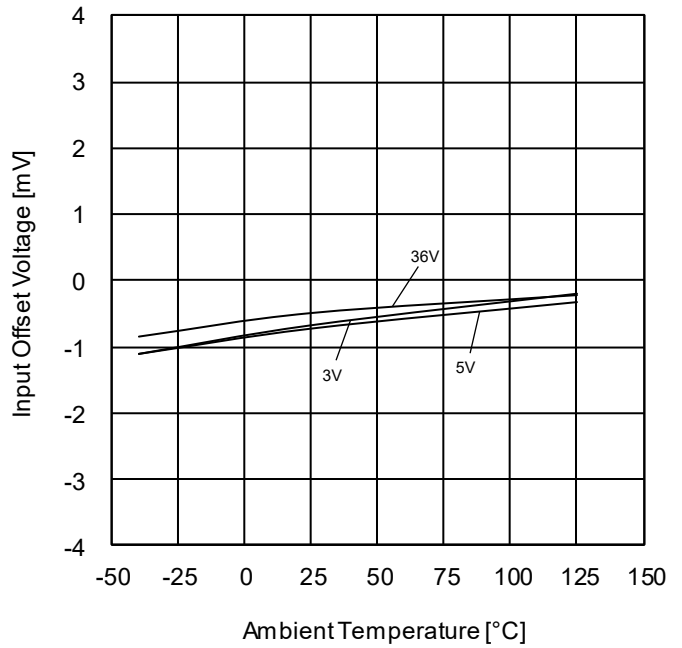

Figure 14. Input Offset Voltage vs Ambient Temperature ($V_{ICM}=V_{CC}/2$, $E_K=-V_{CC}/2$)

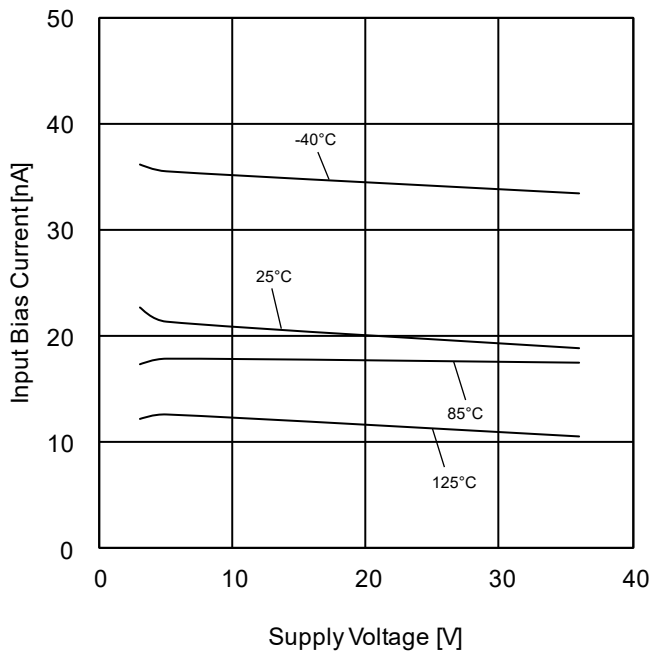

Figure 15. Input Bias Current vs Supply Voltage ($V_{ICM}=V_{CC}/2$, $E_K=-V_{CC}/2$)

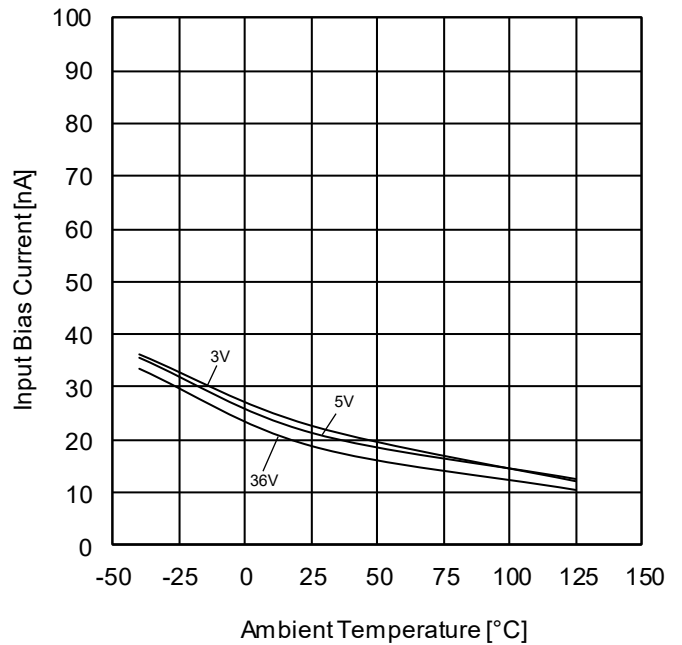

Figure 16. Input Bias Current vs Ambient Temperature ($V_{ICM}=V_{CC}/2$, $E_K=-V_{CC}/2$)

(*) The above data are measurement value of typical sample, they are not guaranteed.
 LM358xxx: -40°C to +85°C LM2904xxx: -40°C to 125°C

Typical Performance Curves - continued

OLM358xxx^{*1}, LM2904xxx^{*2}

^{*1}Last Time Buy.

^{*2}Partial Last Time Buy.

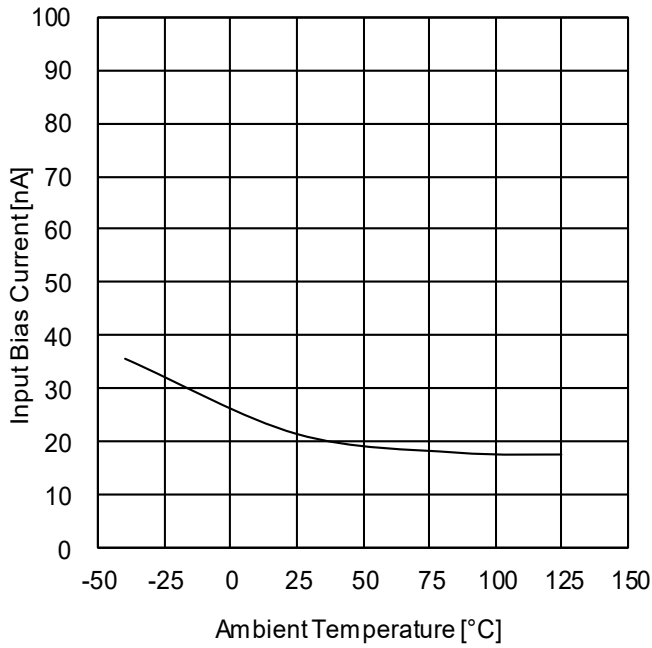

Figure 17. Input Bias Current vs Ambient Temperature ($V_{CC}=30V$, $V_{ICM}=28V$, $E_K=-1.4V$)

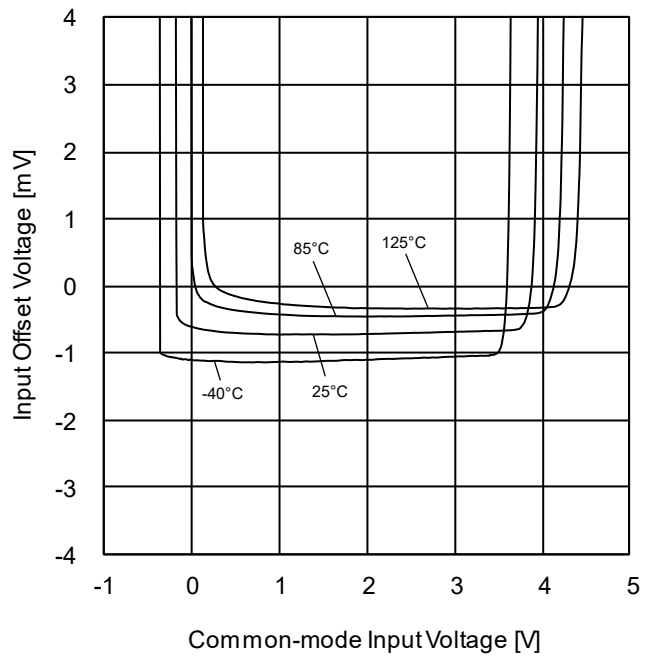

Figure 18. Input Offset Voltage vs Common-mode Input Voltage ($V_{CC}=5V$)

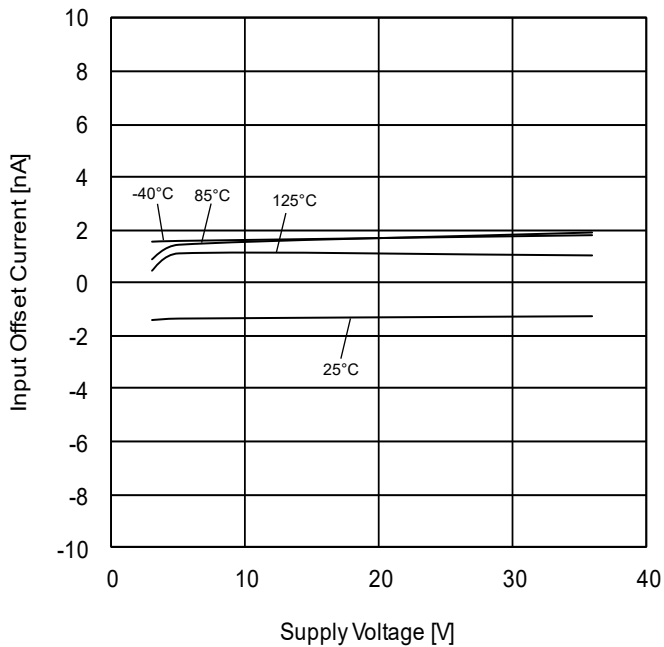

Figure 19. Input Offset Current vs Supply Voltage ($V_{ICM}=V_{CC}/2$, $E_K=-V_{CC}/2$)

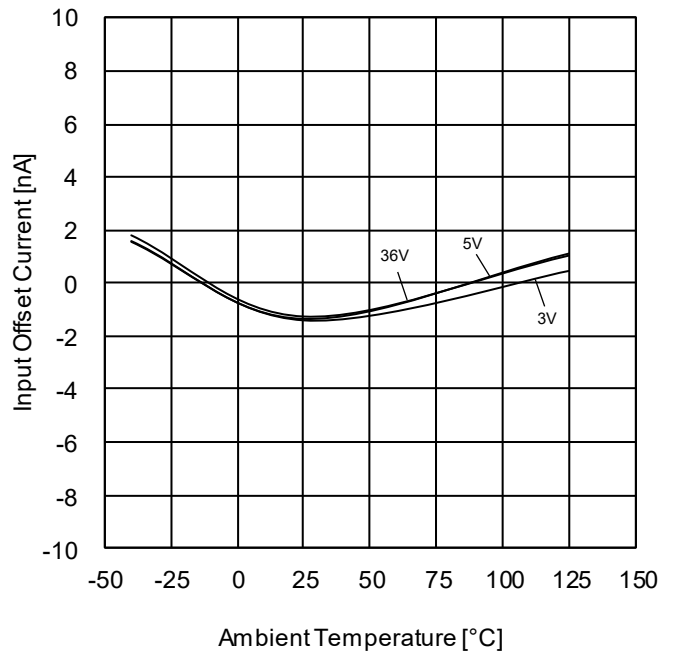

Figure 20. Input Offset Current vs Ambient Temperature ($V_{ICM}=V_{CC}/2$, $E_K=-V_{CC}/2$)

(*) The above data are measurement value of typical sample, they are not guaranteed.
 LM358xxx: -40°C to +85°C LM2904xxx: -40°C to 125°C

Typical Performance Curves - continued

OLM358xxx^{*1}, LM2904xxx^{*2}

^{*1}Last Time Buy.

^{*2}Partial Last Time Buy.

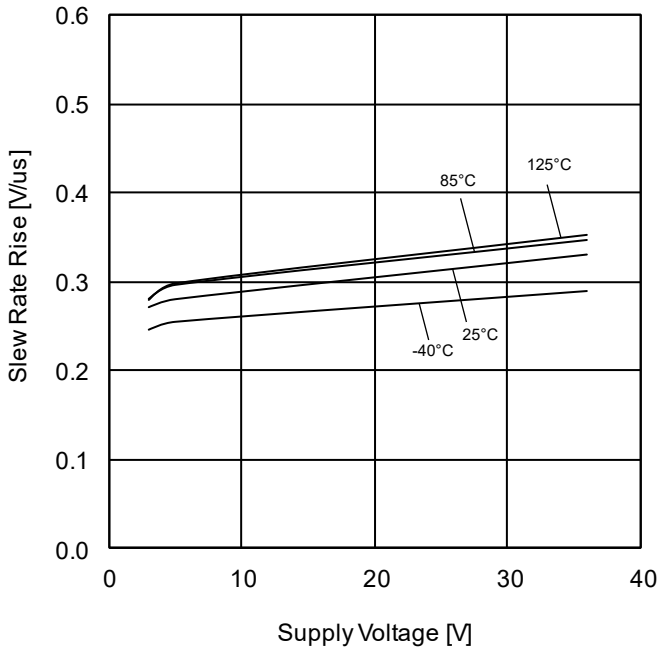

Figure 21. Slew Rate Rise vs Supply Voltage (R_L=2kΩ, Low to High)

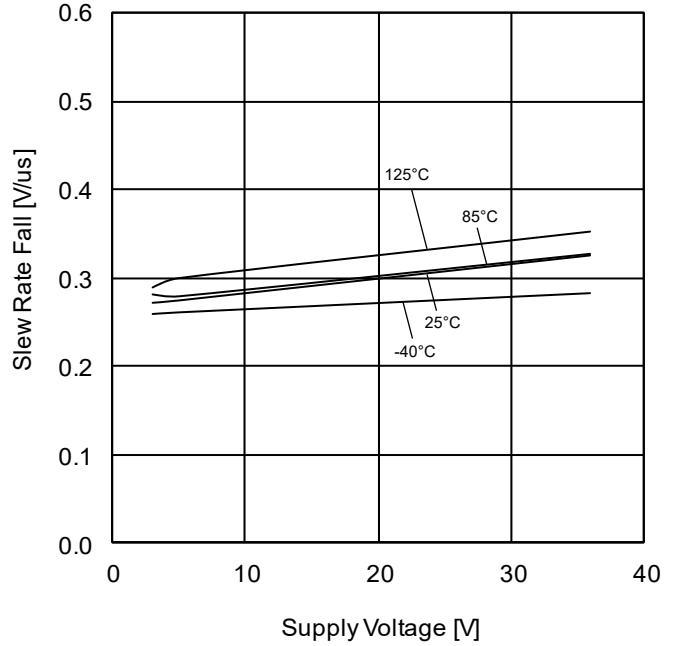

Figure 22. Slew Rate Fall vs Supply Voltage (R_L=2kΩ, High to Low)

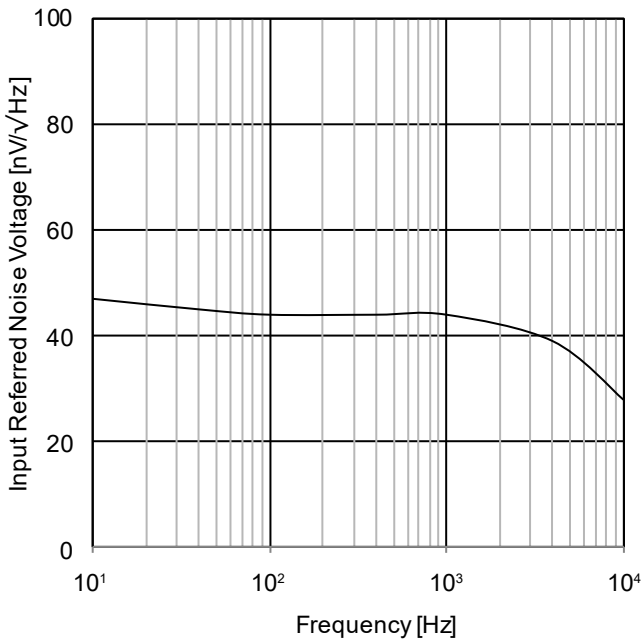

Figure 23. Input Referred Noise Voltage vs Frequency (V_{CC}=5V)

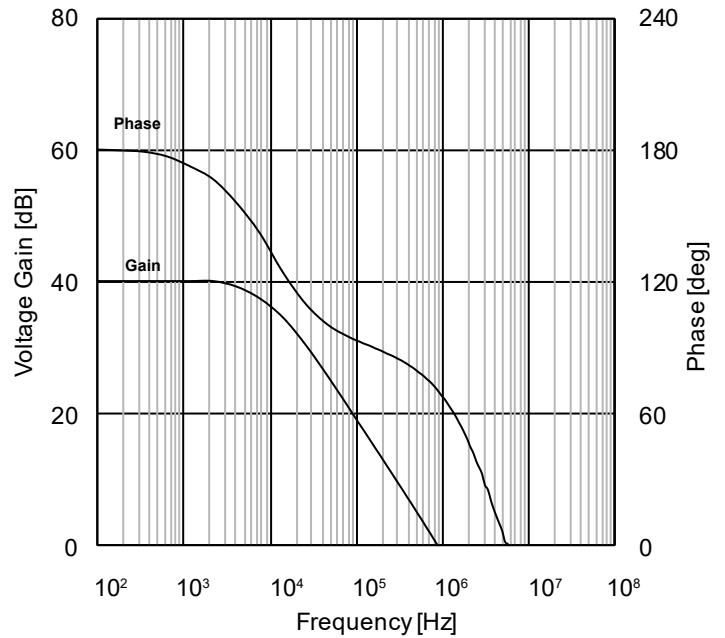

Figure 24. Voltage Gain, Phase vs Frequency (V_{CC}=30V, R_L=2kΩ, C_L=100pF)

(*) The above data are measurement value of typical sample, they are not guaranteed.
 LM358xxx: -40°C to +85°C LM2904xxx: -40°C to 125°C

Typical Performance Curves - continued

OLM358xxx^{*1}, LM2904xxx^{*2}

^{*1}Last Time Buy.

^{*2}Partial Last Time Buy.

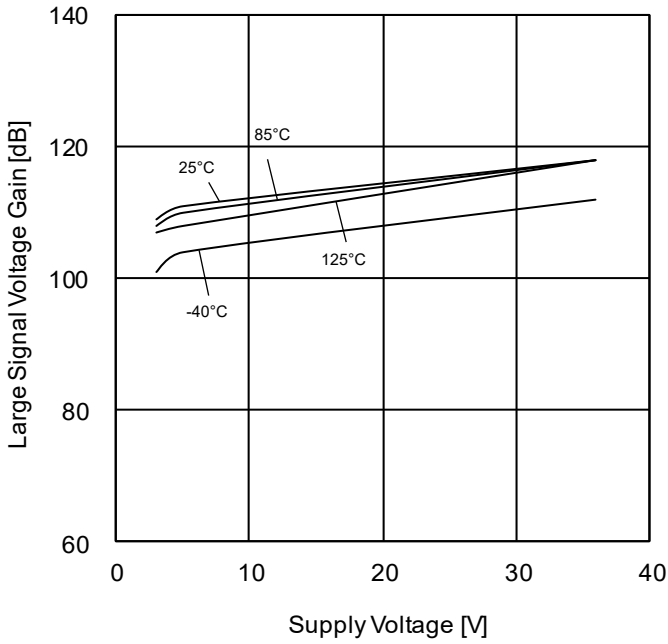

Figure 25. Large Signal Voltage Gain vs Supply Voltage ($R_L=2k\Omega$)

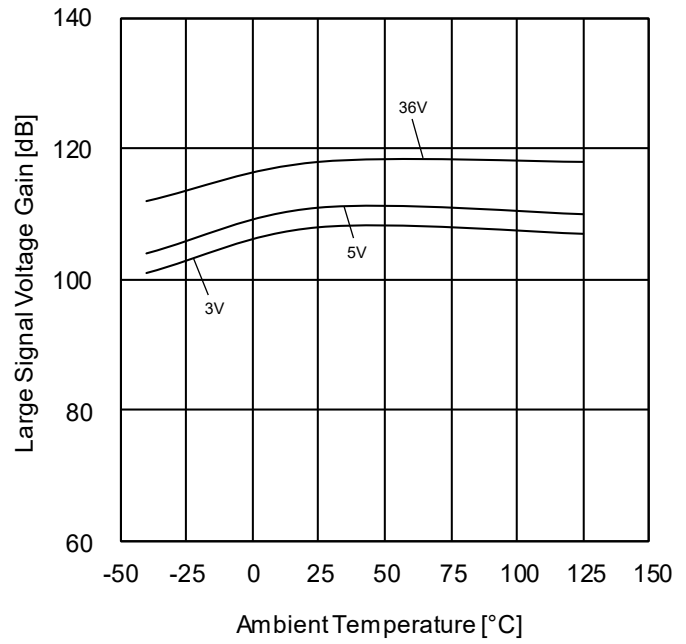

Figure 26. Large Signal Voltage Gain vs Ambient Temperature ($R_L=2k\Omega$)

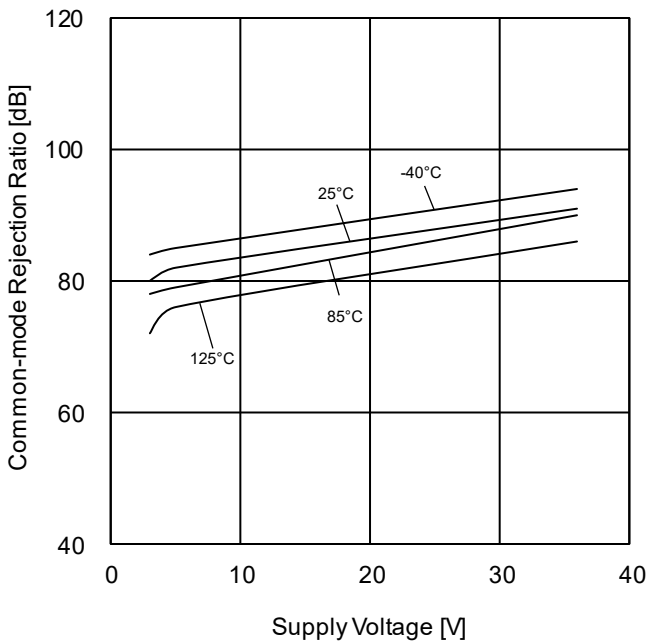

Figure 27. Common-mode Rejection Ratio vs Supply Voltage

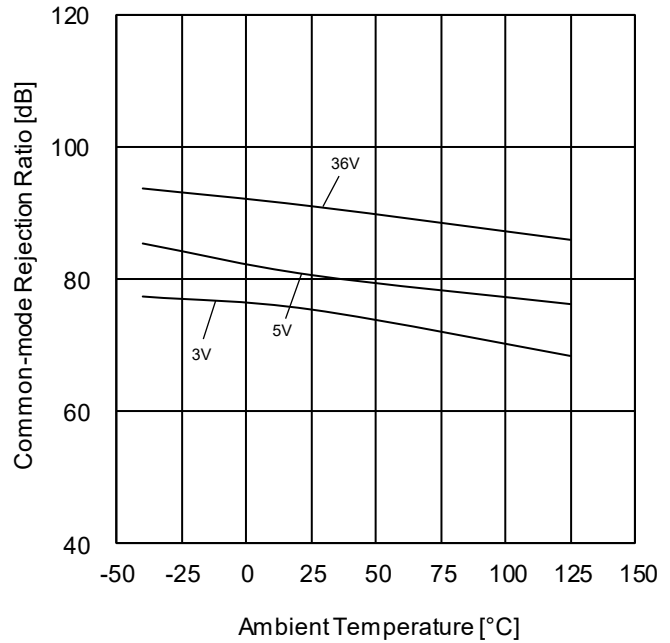

Figure 28. Common-mode Rejection Ratio vs Ambient Temperature

(*) The above data are measurement value of typical sample, they are not guaranteed.
 LM358xxx: -40°C to +85°C LM2904xxx: -40°C to 125°C

Typical Performance Curves - continued

OLM358xxx^{*1}, LM2904xxx^{*2}

^{*1}Last Time Buy.

^{*2}Partial Last Time Buy.

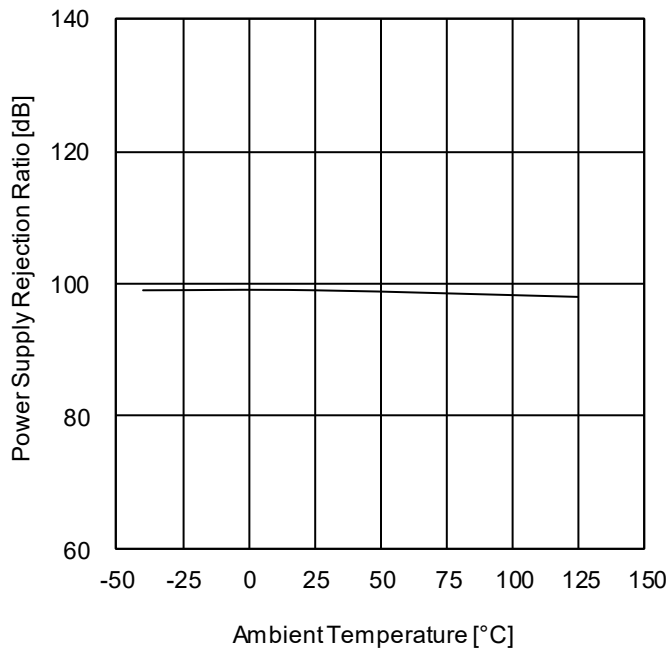

Figure 29. Power Supply Rejection Ratio vs Ambient Temperature

(*) The above data are measurement value of typical sample, they are not guaranteed.
 LM358xxx: -40°C to +85°C LM2904xxx: -40°C to 125°C

Typical Performance Curves - continued

OLM324xxx^{*1}, LM2902xxx^{*2}

^{*1}Last Time Buy.

^{*2}Partial Last Time Buy.

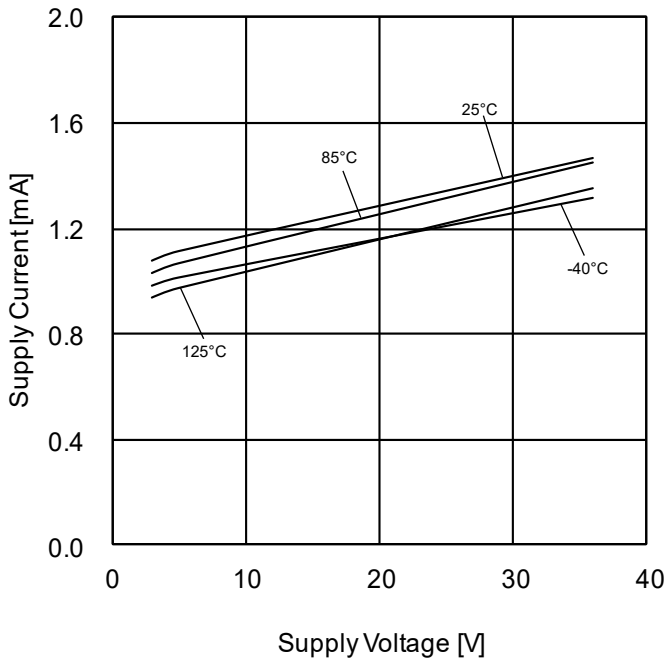

Figure 30. Supply Current vs Supply Voltage

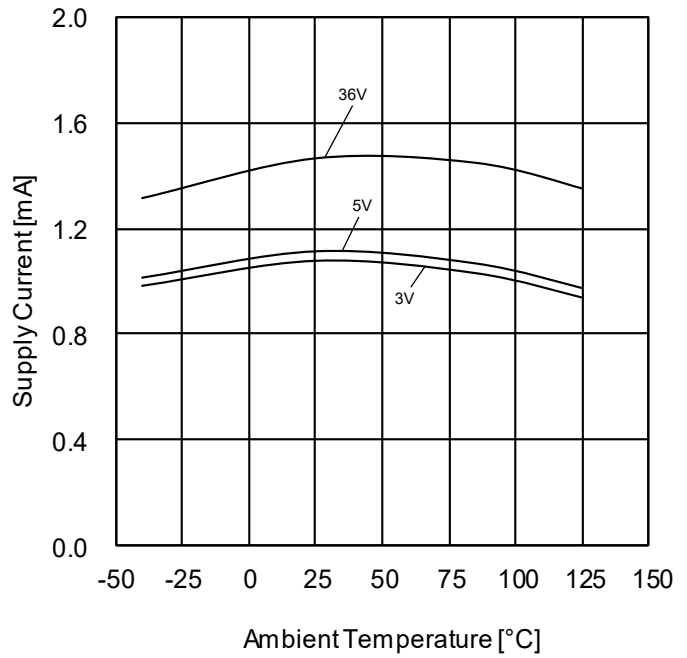

Figure 31. Supply Current vs Ambient Temperature

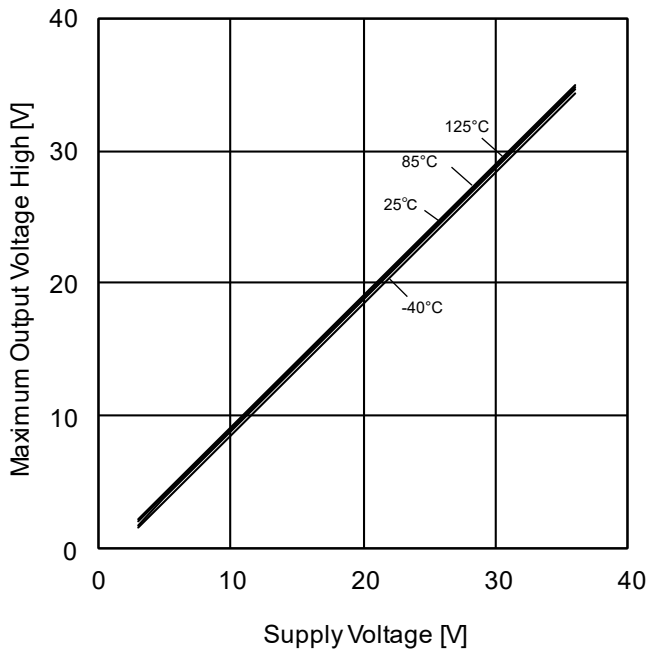

Figure 32. Maximum Output Voltage (High) vs Supply Voltage ($R_L=10k\Omega$)

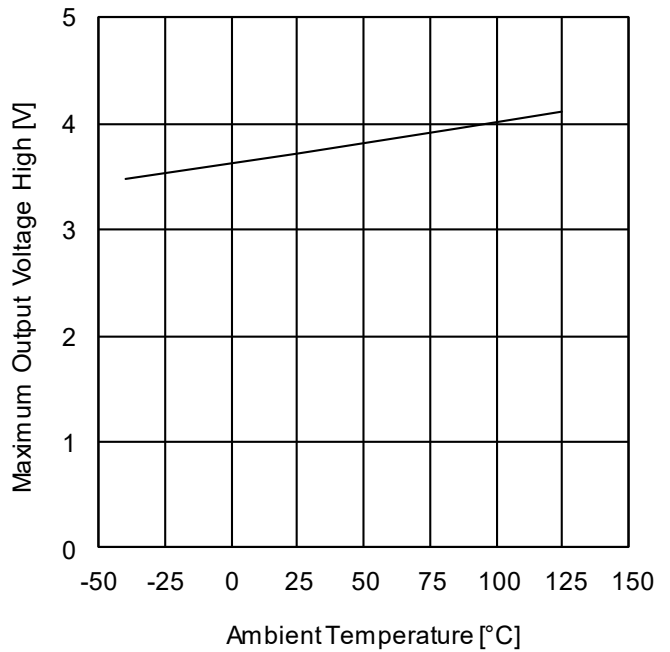

Figure 33. Maximum Output Voltage (High) vs Ambient Temperature ($V_{CC}=5V, R_L=10k\Omega$)

(*) The above data are measurement value of typical sample, they are not guaranteed.
 LM324xxx: -40°C to +85°C LM2902xxx: -40°C to 125°C

Typical Performance Curves - continued

OLM324xxx^{*1}, LM2902xxx^{*2}

^{*1}Last Time Buy.

^{*2}Partial Last Time Buy.

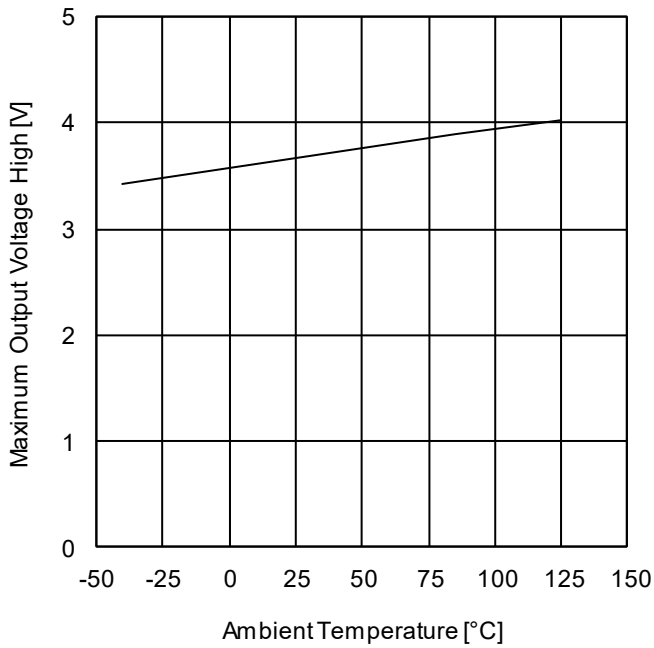

Figure 34. Maximum Output Voltage (High) vs Ambient Temperature ($V_{CC}=5V$, $R_L=2k\Omega$)

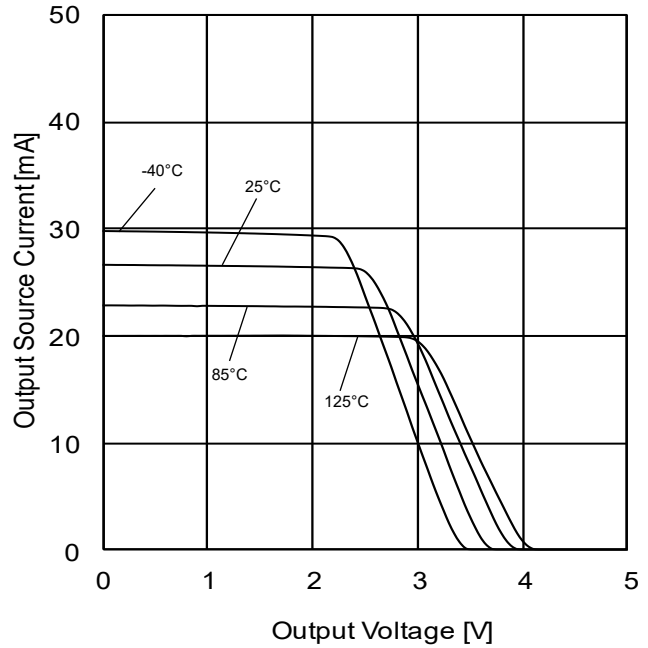

Figure 35. Output Source Current vs Output Voltage ($V_{CC}=5V$)

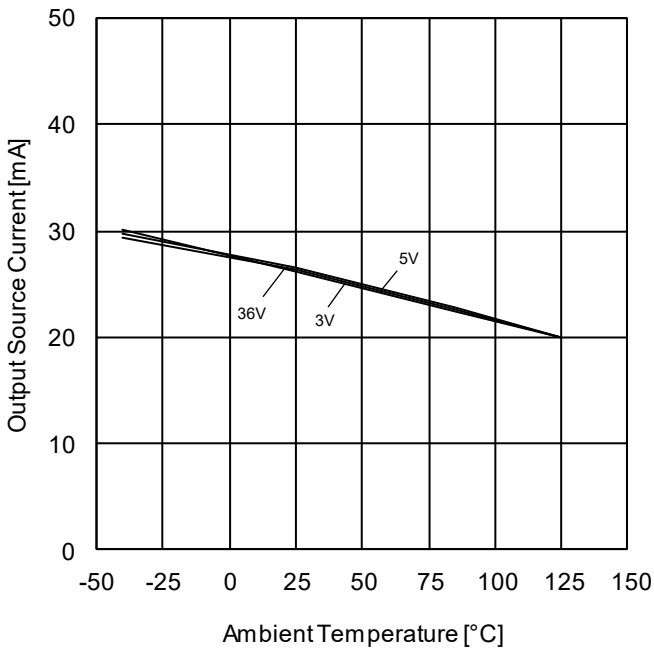

Figure 36. Output Source Current vs Ambient Temperature ($V_{OUT}=0V$)

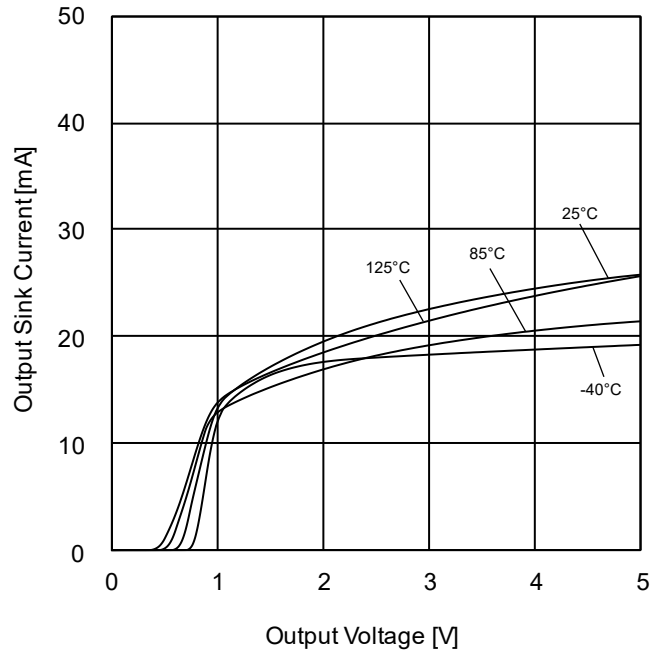

Figure 37. Output Sink Current vs Output Voltage ($V_{CC}=5V$)

(*) The above data are measurement value of typical sample, they are not guaranteed.
 LM324xxx: -40°C to +85°C LM2902xxx: -40°C to 125°C

Typical Performance Curves - continued

OLM324xxx^{*1}, LM2902xxx^{*2}

^{*1}Last Time Buy.

^{*2}Partial Last Time Buy.

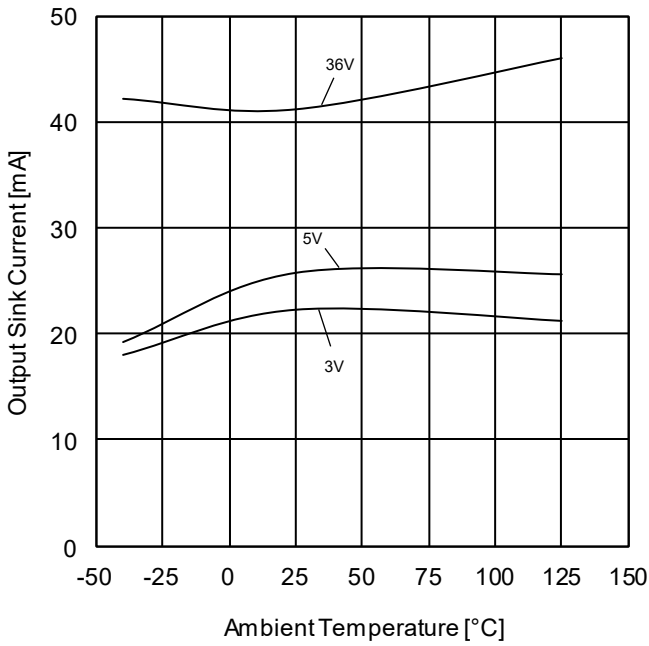

Figure 38. Output Sink Current vs Ambient Temperature ($V_{OUT}=V_{CC}$)

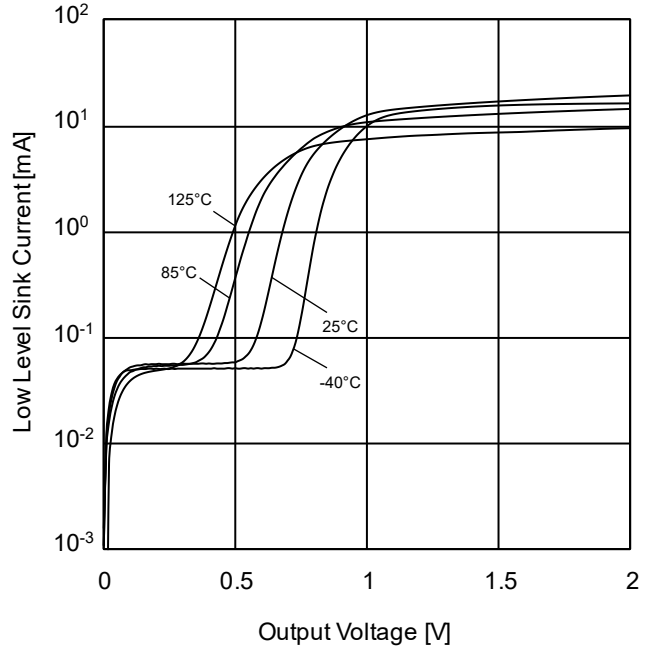

Figure 39. Low Level Sink Current vs Output Voltage ($V_{CC}=5V$)

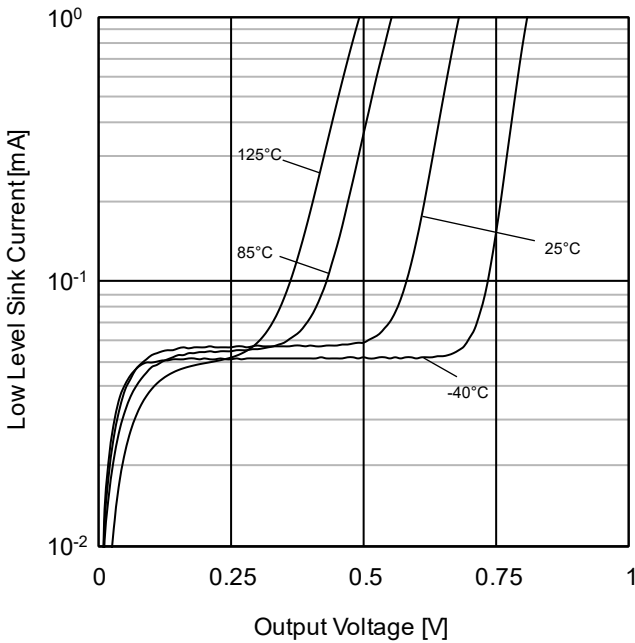

Figure 40. Low Level Sink Current vs Output Voltage (Enlarged view) ($V_{CC}=5V$)

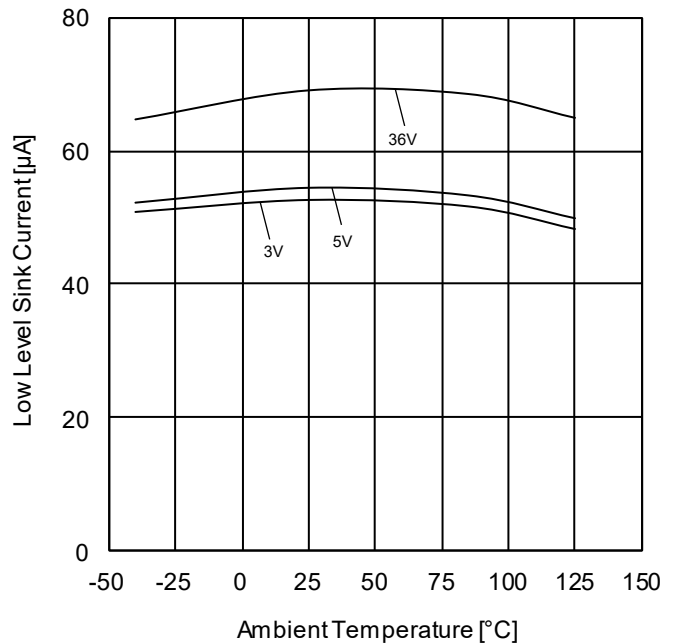

Figure 41. Low Level Sink Current vs Ambient Temperature ($V_{OUT}=200mV$)

(*) The above data are measurement value of typical sample, they are not guaranteed.
 LM324xxx: -40°C to +85°C LM2902xxx: -40°C to 125°C

Typical Performance Curves - continued

OLM324xxx^{*1}, LM2902xxx^{*2}

^{*1}Last Time Buy.

^{*2}Partial Last Time Buy.

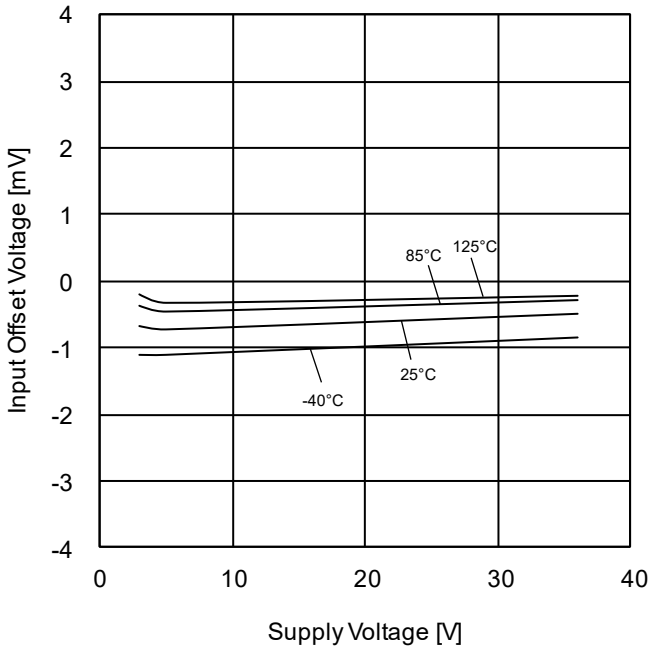

Figure 42. Input Offset Voltage vs Supply Voltage ($V_{ICM}=V_{CC}/2$, $E_K=-V_{CC}/2$)

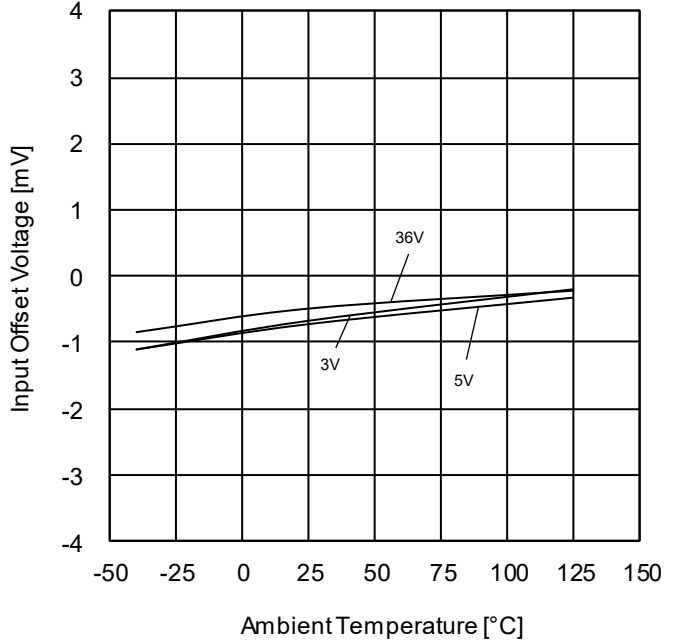

Figure 43. Input Offset Voltage vs Ambient Temperature ($V_{ICM}=V_{CC}/2$, $E_K=-V_{CC}/2$)

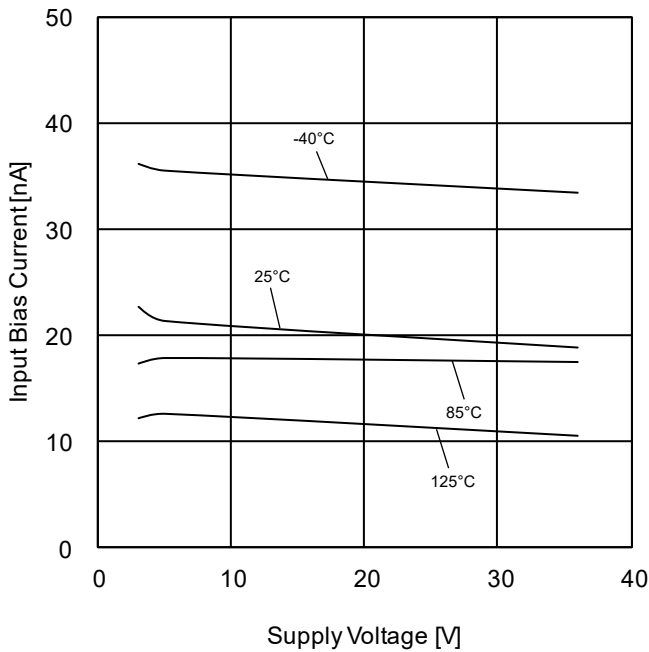

Figure 44. Input Bias Current vs Supply Voltage ($V_{ICM}=V_{CC}/2$, $E_K=-V_{CC}/2$)

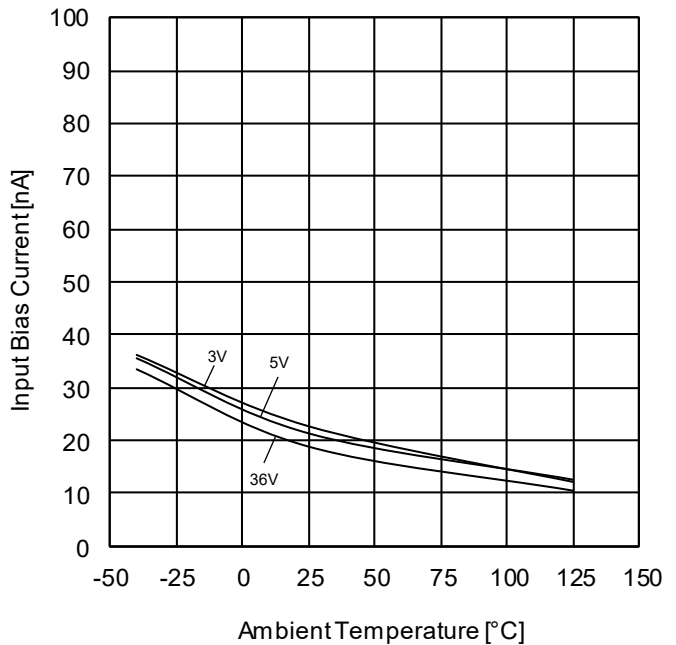

Figure 45. Input Bias Current vs Ambient Temperature ($V_{ICM}=V_{CC}/2$, $E_K=-V_{CC}/2$)

(*) The above data are measurement value of typical sample, they are not guaranteed.
 LM324xxx: -40°C to +85°C LM2902xxx: -40°C to 125°C

Typical Performance Curves - continued

OLM324xxx^{*1}, LM2902xxx^{*2}

^{*1}Last Time Buy.

^{*2}Partial Last Time Buy.

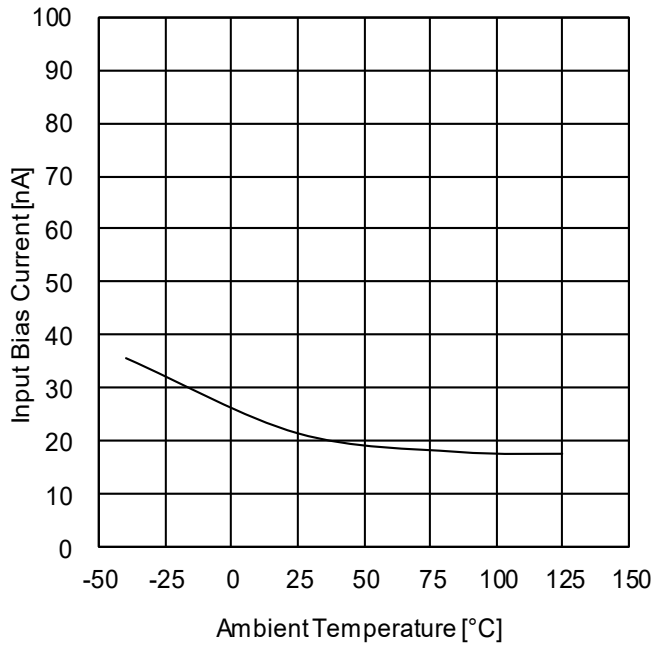

Figure 46. Input Bias Current vs Ambient Temperature ($V_{CC}=30V$, $V_{ICM}=28V$, $E_K=-1.4V$)

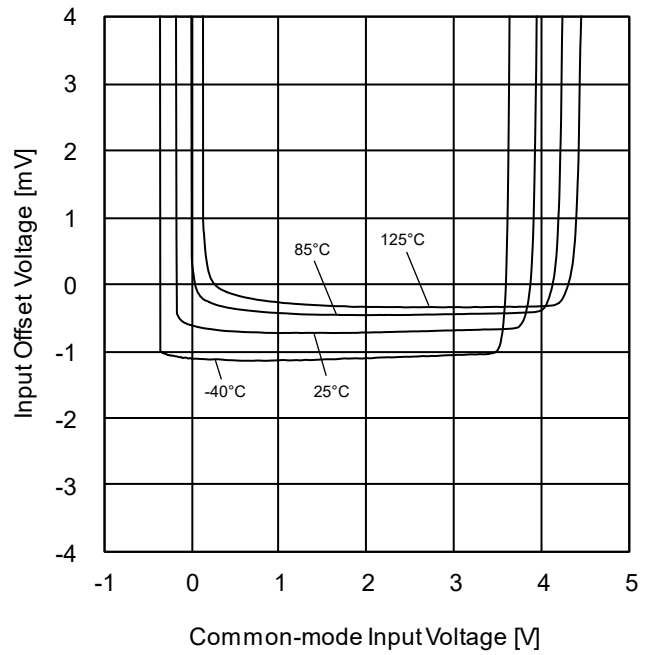

Figure 47. Input Offset Voltage vs Common-mode Input Voltage ($V_{CC}=5V$)

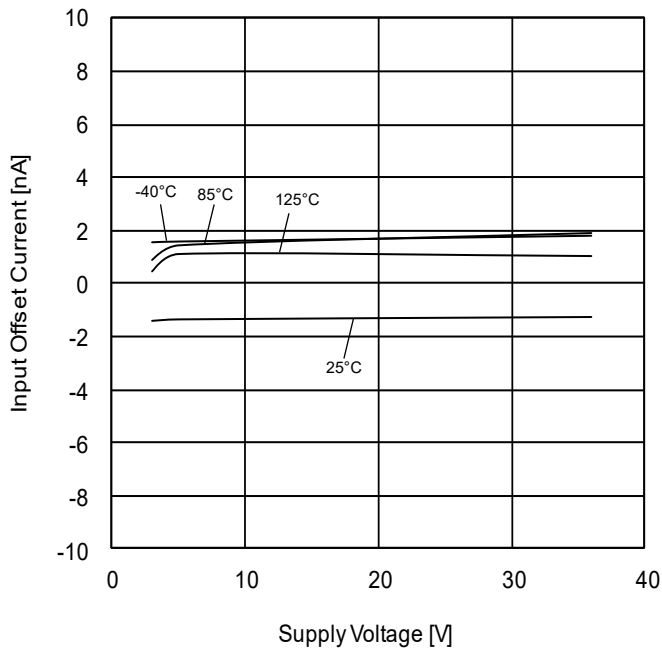

Figure 48. Input Offset Current vs Supply Voltage ($V_{ICM}=V_{CC}/2$, $E_K=-V_{CC}/2$)

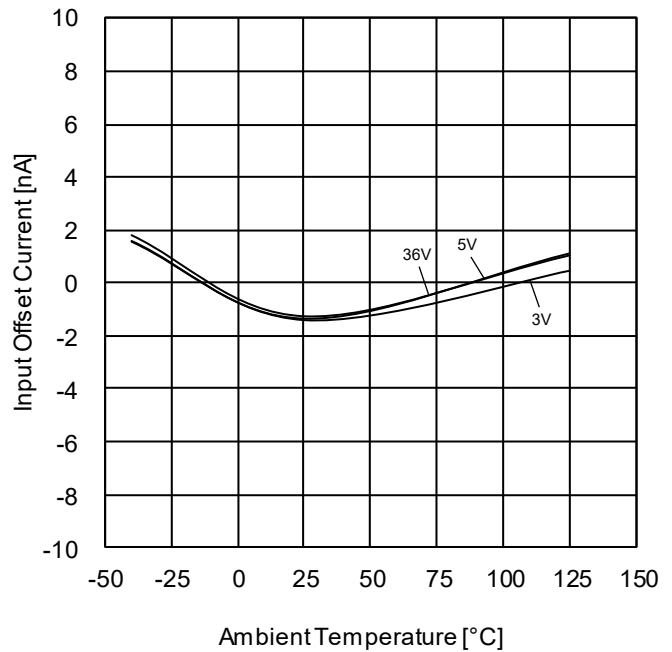

Figure 49. Input Offset Current vs Ambient Temperature ($V_{ICM}=V_{CC}/2$, $E_K=-V_{CC}/2$)

(*) The above data are measurement value of typical sample, they are not guaranteed.
 LM324xxx: -40°C to +85°C LM2902xxx: -40°C to 125°C

Typical Performance Curves - continued

OLM324xxx^{*1}, LM2902xxx^{*2}

^{*1}Last Time Buy.

^{*2}Partial Last Time Buy.

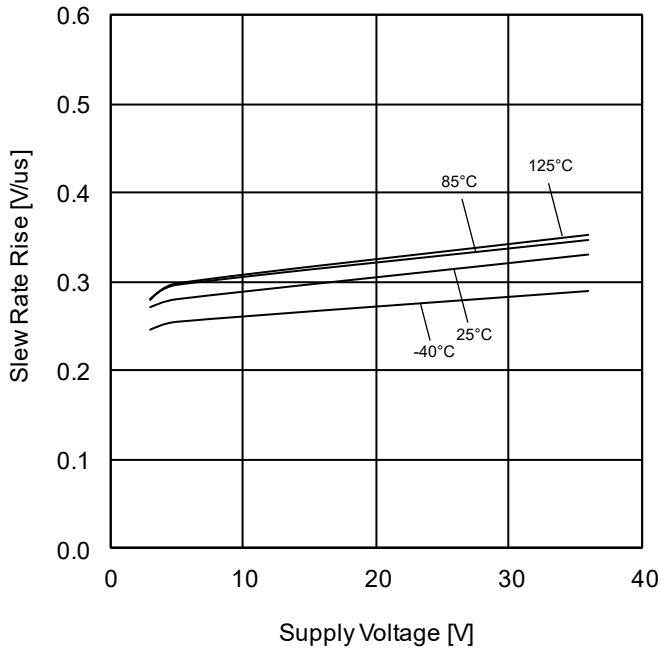

Figure 50. Slew Rate Rise vs Supply Voltage (R_L=2kΩ, Low to High)

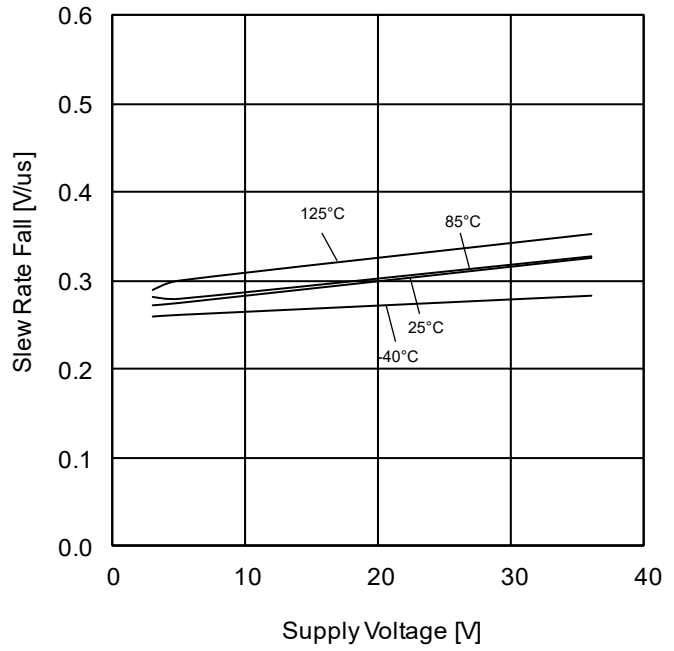

Figure 51. Slew Rate Fall vs Supply Voltage (R_L=2kΩ, High to Low)

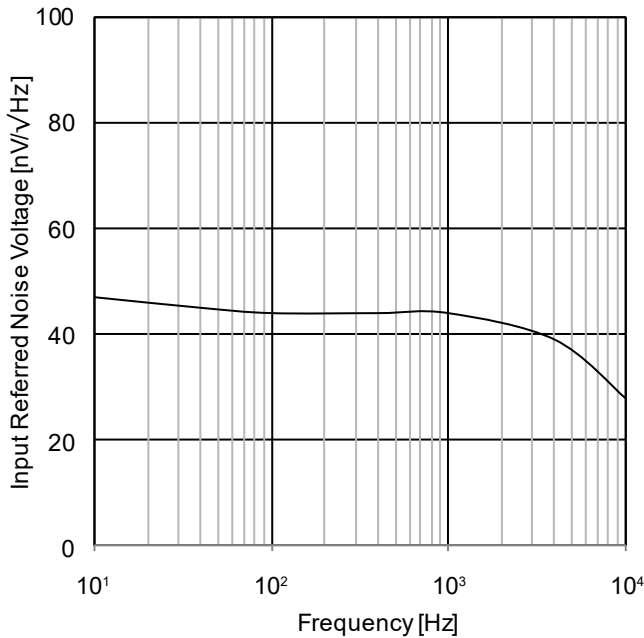

Figure 52. Input Referred Noise Voltage vs Frequency (V_{CC}=5V)

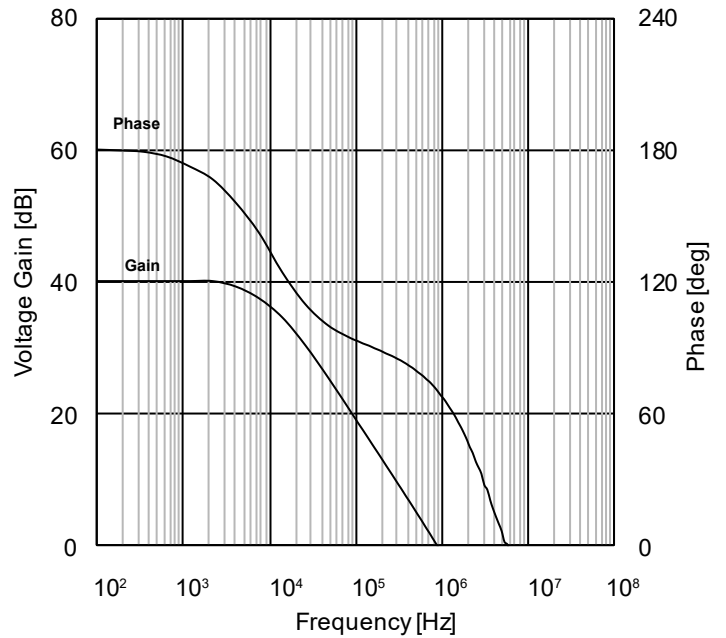

Figure 53. Voltage Gain, Phase vs Frequency (V_{CC}=30V, R_L=2kΩ, C_L=100pF)

(*) The above data are measurement value of typical sample, they are not guaranteed.
 LM324xxx: -40°C to +85°C LM2902xxx: -40°C to 125°C

Typical Performance Curves - continued

OLM324xxx^{*1}, LM2902xxx^{*2}

^{*1}Last Time Buy.

^{*2}Partial Last Time Buy.

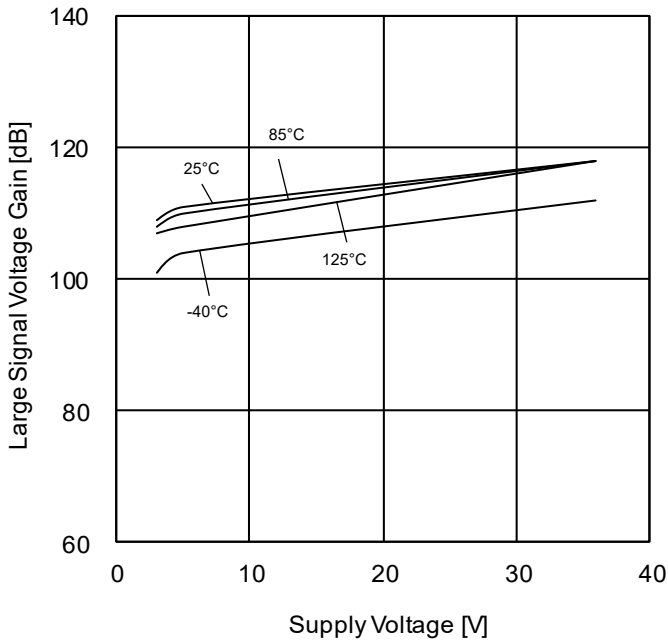

Figure 54. Large Signal Voltage Gain vs Supply Voltage ($R_L=2k\Omega$)

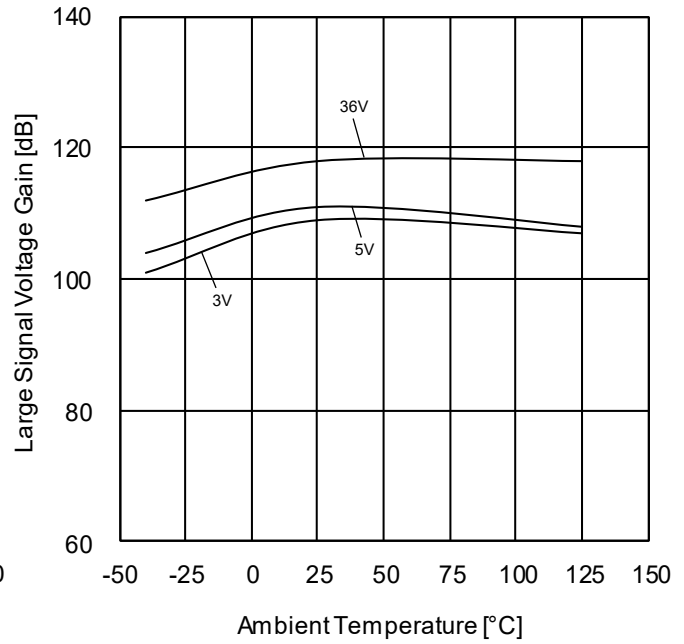

Figure 55. Large Signal Voltage Gain vs Ambient Temperature ($R_L=2k\Omega$)

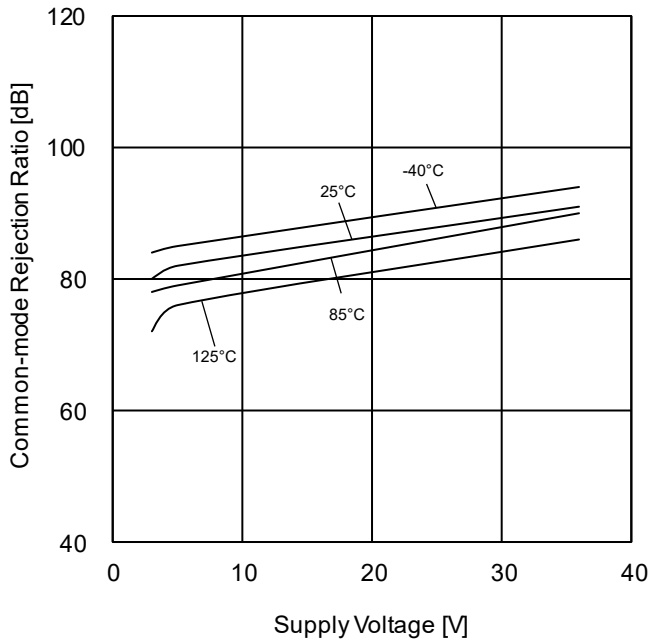

Figure 56. Common-mode Rejection Ratio vs Supply Voltage

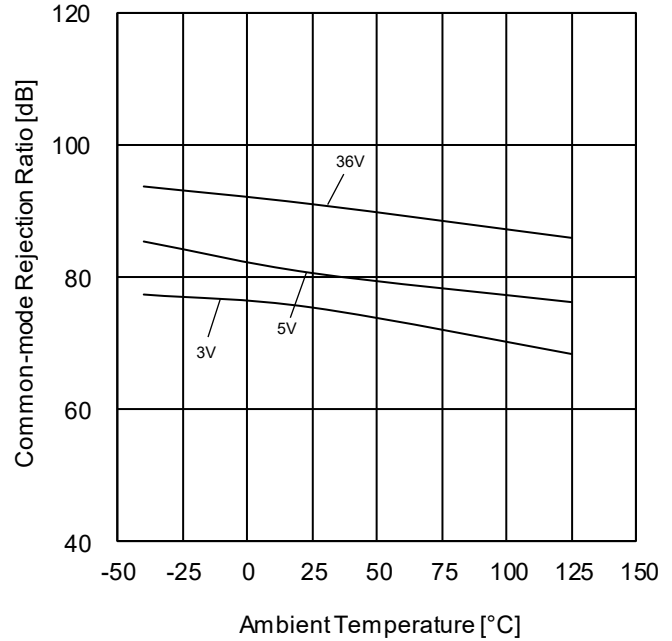

Figure 57. Common-mode Rejection Ratio vs Ambient Temperature

(*) The above data are measurement value of typical sample, they are not guaranteed.
 LM324xxx: -40°C to +85°C LM2902xxx: -40°C to 125°C

Typical Performance Curves - continued

OLM324xxx^{*1}, LM2902xxx^{*2}

^{*1} Last Time Buy.

^{*2} Partial Last Time Buy.

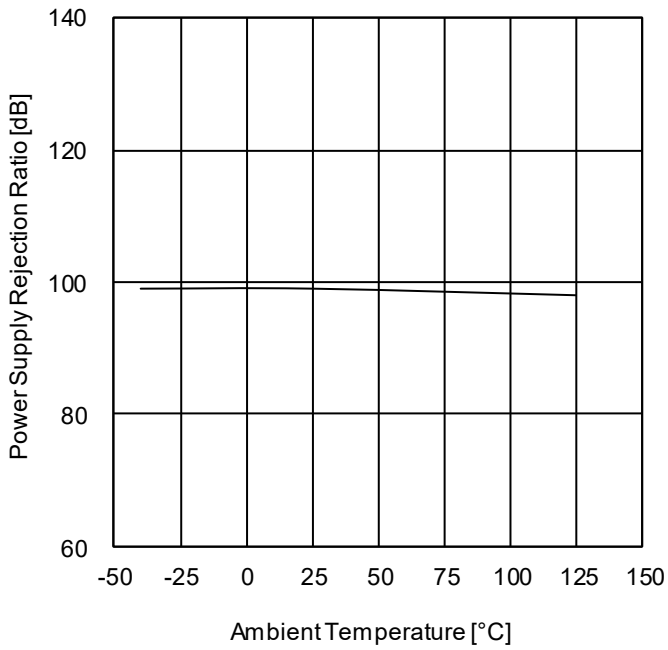

Figure 58. Power Supply Rejection Ratio vs Ambient Temperature

(*) The above data are measurement value of typical sample, they are not guaranteed.
 LM324xxx: -40°C to +85°C LM2902xxx: -40°C to 125°C

Application Information
NULL method condition for Test Circuit 1

V_{CC}, V_{EE}, E_K, V_{ICM} Unit: V

Parameter	V _F	SW1	SW2	SW3	V _{CC}	V _{EE}	E _K	V _{ICM}	Calculation
Input Offset Voltage	V _{F1}	ON	ON	OFF	5 to 30	0	-1.4	0	1
Input Offset Current	V _{F2}	OFF	OFF	OFF	5	0	-1.4	0	2
Input Bias Current	V _{F3}	OFF	ON	OFF	5	0	-1.4	0	3
	V _{F4}	ON	OFF						
Large Signal Voltage Gain	V _{F5}	ON	ON	ON	15	0	-1.4	0	4
	V _{F6}						-11.4		
Common-mode Rejection Ratio (Input Common-mode Voltage Range)	V _{F7}	ON	ON	OFF	5	0	-1.4	0	5
	V _{F8}						-1.4	3.5	
Power Supply Rejection Ratio	V _{F9}	ON	ON	OFF	5	0	-1.4	0	6
	V _{F10}				30				

- Calculation -

1. Input Offset Voltage (V_{IO})

$$V_{IO} = \frac{|V_{F1}|}{1 + R_F/R_S} \quad [V]$$

2. Input Offset Current (I_{IO})

$$I_{IO} = \frac{|V_{F2} - V_{F1}|}{R_I \times (1 + R_F/R_S)} \quad [A]$$

3. Input Bias Current (I_B)

$$I_B = \frac{|V_{F4} - V_{F3}|}{2 \times R_I \times (1 + R_F/R_S)} \quad [A]$$

4. Large Signal Voltage Gain (A_v)

$$A_v = 20 \text{Log} \frac{\Delta E_K \times (1 + R_F/R_S)}{|V_{F6} - V_{F5}|} \quad [dB]$$

5. Common-mode Rejection Ratio (CMRR)

$$\text{CMRR} = 20 \text{Log} \frac{\Delta V_{ICM} \times (1 + R_F/R_S)}{|V_{F8} - V_{F7}|} \quad [dB]$$

6. Power Supply Rejection Ratio (PSRR)

$$\text{PSRR} = 20 \text{Log} \frac{\Delta V_{CC} \times (1 + R_F/R_S)}{|V_{F10} - V_{F9}|} \quad [dB]$$

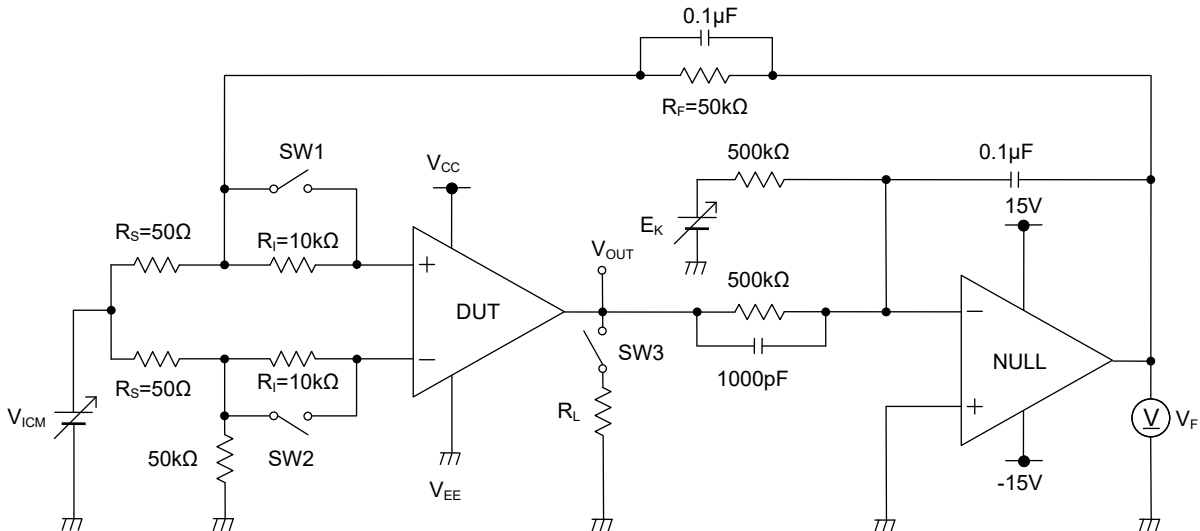

Figure 59. Test Circuit 1 (One Channel Only)

Application Information – continued
Switch Condition for Test Circuit 2

Parameter	SW1	SW2	SW3	SW4	SW5	SW6	SW7	SW8	SW9	SW10	SW11	SW12	SW13
Supply Current	OFF	OFF	OFF	ON	OFF	ON	OFF	OFF	OFF	OFF	OFF	OFF	OFF
Maximum Output Voltage(High)	OFF	OFF	ON	OFF	OFF	ON	OFF	OFF	ON	OFF	OFF	ON	OFF
Maximum Output Voltage(Low)	OFF	OFF	ON	OFF	OFF	ON	OFF	OFF	OFF	OFF	OFF	ON	OFF
Output Source Current	OFF	OFF	ON	OFF	OFF	ON	OFF	OFF	OFF	OFF	OFF	OFF	ON
Output Sink Current	OFF	OFF	ON	OFF	OFF	ON	OFF	OFF	OFF	OFF	OFF	OFF	ON
Slew Rate	OFF	OFF	OFF	ON	OFF	OFF	OFF	ON	ON	ON	OFF	OFF	OFF
Gain Bandwidth Product	OFF	ON	OFF	OFF	ON	ON	OFF	OFF	ON	ON	OFF	OFF	OFF
Input Referred Noise Voltage	ON	OFF	OFF	OFF	ON	ON	OFF	OFF	OFF	OFF	ON	OFF	OFF

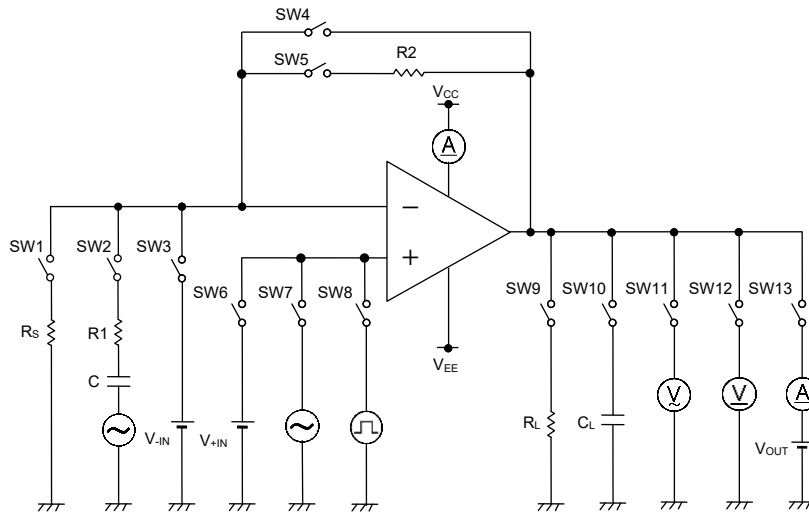

Figure 60. Test Circuit 2 (Each Op-Amp)

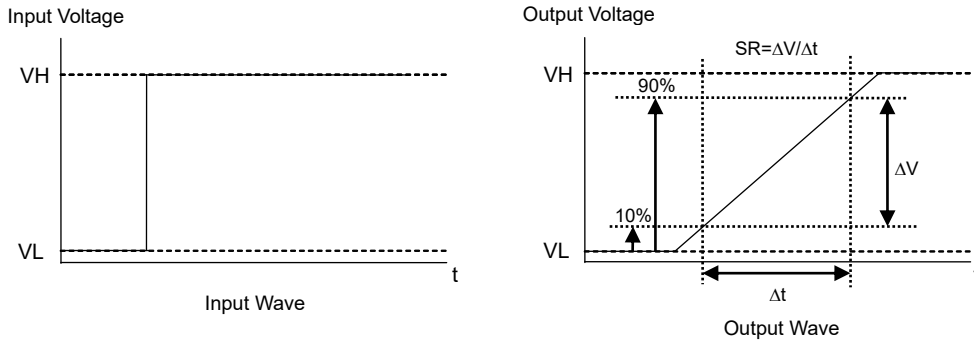

Figure 61. Slew Rate Input and Output Wave

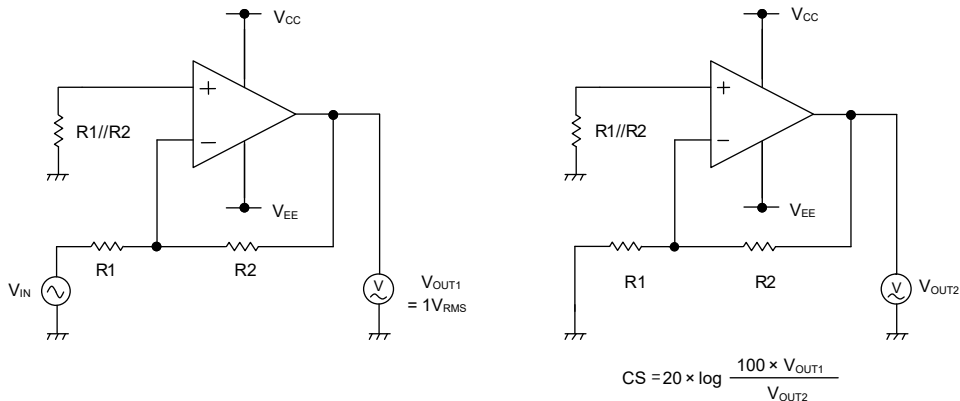

Figure 62. Test Circuit 3 (Channel Separation)
(R1=1kΩ,R2=100kΩ)

Application Information – continued

1. Unused Circuits

It is recommended to apply the connection (see Figure 63) and set the non-inverting input pin at a potential within the Input Common-mode Voltage Range (V_{ICM}) for any unused circuit.

2. Input Voltage

Regardless of the supply voltage, applying $V_{EE}+36V$ to the input pin is possible without causing deterioration of the electrical characteristics or destruction. However, this does not ensure normal circuit operation. Please note that the circuit operates normally only when the input voltage is within the common mode input voltage range of the electric characteristics.

3. Power Supply (Single/Dual)

The operational amplifiers operate when the voltage supplied is between VCC pin and VEE pin. Therefore, the single supply operational amplifiers can be used as dual supply operational amplifiers as well.

4. IC Handling

When pressure is applied to the IC through warp on the printed circuit board, the characteristics may fluctuate due to the piezo effect. Be careful with the warp on the printed circuit board.

5. The IC Destruction Caused by Capacitive Load

The IC may be damaged when VCC pin and VEE pin is shorted with the charged output pin capacitor. When IC is used as an operational amplifier or as an application circuit where oscillation is not activated by an output capacitor, output capacitor must be kept below $0.1\mu F$ in order to prevent the damage mentioned above.

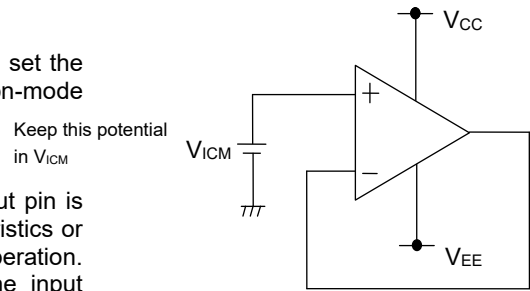

Figure 63. The Example of Application Circuit for Unused Op-amp

I/O Equivalent Circuit

Symbol	Pin No.	Equivalent Circuit
+IN -IN	LM358xxx ^{*1} , LM2904xxx ^{*2} : 2,3,5,6 LM324xxx ^{*1} , LM2902xxx ^{*2} : 2,3,5,6,9,10,12,13	
OUT	LM358xxx ^{*1} , LM2904xxx ^{*2} : 1,7 LM324xxx ^{*1} , LM2902xxx ^{*2} : 1,7,8,14	
VCC	LM358xxx ^{*1} , LM2904xxx ^{*2} : 8 LM324xxx ^{*1} , LM2902xxx ^{*2} : 4	

^{*1}Last Time Buy.
^{*2}Partial Last Time Buy.

Examples of Circuit

○Voltage Follower

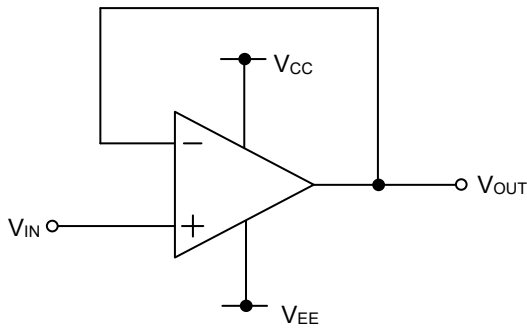

Figure 64. Voltage Follower Circuit

Voltage gain is 0dB.

Using this circuit, the output voltage (V_{OUT}) is configured to be equal to the input voltage (V_{IN}). This circuit also stabilizes the output voltage (V_{OUT}) due to high input impedance and low output impedance. Computation for output voltage (V_{OUT}) is shown below.

$$V_{OUT}=V_{IN}$$

○Inverting Amplifier

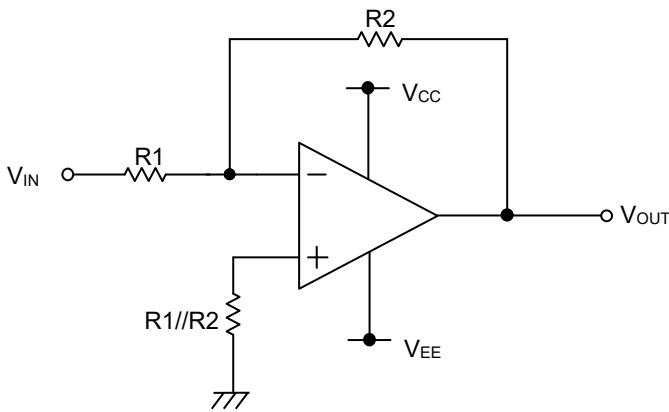

Figure 65. Inverting Amplifier Circuit

For inverting amplifier, input voltage (V_{IN}) is amplified by a voltage gain and depends on the ratio of $R1$ and $R2$. The out-of-phase output voltage is shown in the next expression

$$V_{OUT}=-\left(\frac{R2}{R1}\right) \cdot V_{IN}$$

This circuit has input impedance equal to $R1$.

○Non-inverting Amplifier

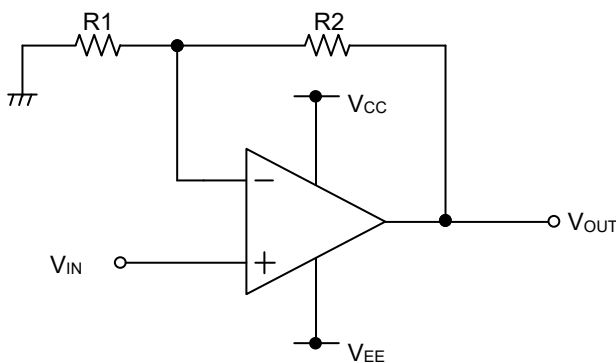

Figure 66. Non-inverting Amplifier Circuit

For non-inverting amplifier, input voltage (V_{IN}) is amplified by a voltage gain, which depends on the ratio of $R1$ and $R2$. The output voltage (V_{OUT}) is in-phase with the input voltage (V_{IN}) and is shown in the next expression.

$$V_{OUT}=\left(1 + \frac{R2}{R1}\right) \cdot V_{IN}$$

Effectively, this circuit has high input impedance since its input side is the same as that of the operational amplifier.

Power Dissipation

Power dissipation (total loss) indicates the power that the IC can consume at $T_A=25^\circ\text{C}$ (normal temperature). As the IC consumes power, it heats up, causing its temperature to rise above the ambient temperature. The allowable temperature that the IC can accept is limited. This depends on the circuit configuration, manufacturing process, and consumable power.

Power dissipation is determined by the allowable temperature within the IC (maximum junction temperature) and the thermal resistance of the package used (heat dissipation capability). Maximum junction temperature is typically equal to the maximum storage temperature. The heat generated through the consumption of power by the IC radiates from the mold resin or lead frame of the package. Thermal resistance, represented by the symbol $\theta_{JA}^\circ\text{C/W}$, indicates this heat dissipation capability. Similarly, the temperature of an IC inside its package can be estimated by thermal resistance.

Figure 67(a) shows the model of the thermal resistance of a package. The equation below shows how to compute the Thermal resistance (θ_{JA}), given the ambient temperature (T_A), maximum junction temperature (T_{Jmax}), and power dissipation (P_D).

$$\theta_{JA} = (T_{Jmax} - T_A) / P_D \quad ^\circ\text{C/W}$$

The Derating Curve in Figure 67(b) indicates the power that the IC can consume with reference to ambient temperature. Power consumption of the IC begins to attenuate at certain temperatures. This gradient is determined by Thermal resistance (θ_{JA}), which depends on the chip size, power consumption, package, ambient temperature, package condition, wind velocity, etc. This may also vary even when the same of package is used. Thermal reduction curve indicates a reference value measured at a specified condition. Figures 67(c) to (f) show the examples of derating curves for LM358xxx, LM2904xxx, LM324xxx, and LM2902xxx respectively.

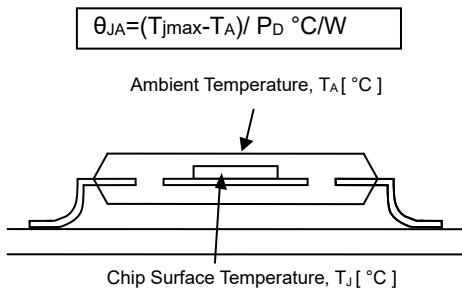

(a) Thermal Resistance

Power Dissipation of LSI [W]

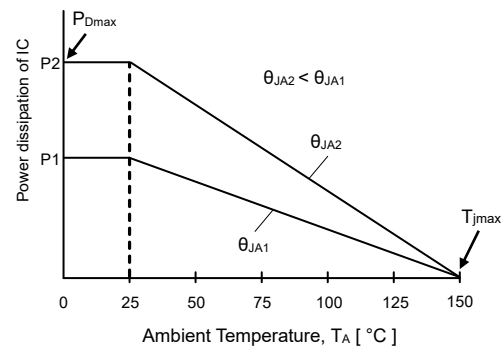

(b) Derating Curve

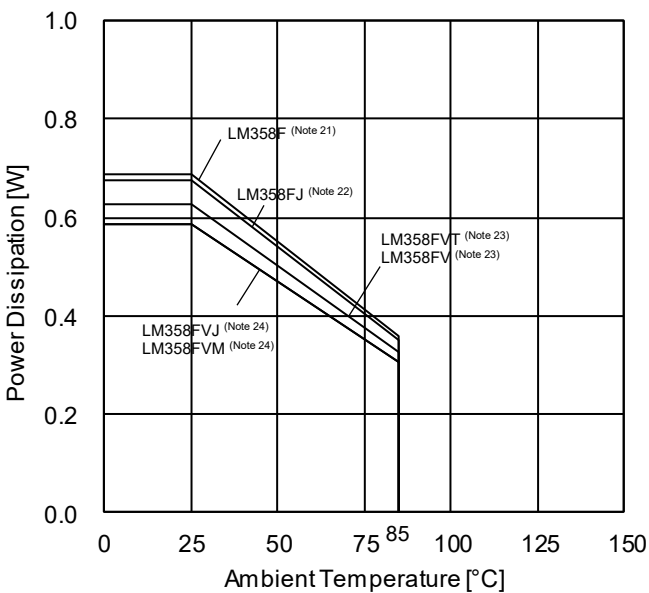

(c) LM358xxx*1

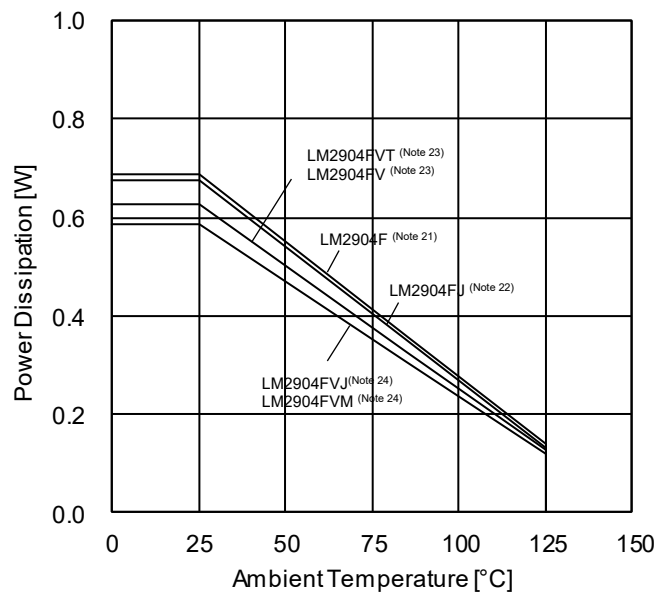

(d) LM2904xxx*2

*1 Last Time Buy.
*2 Partial Last Time Buy.

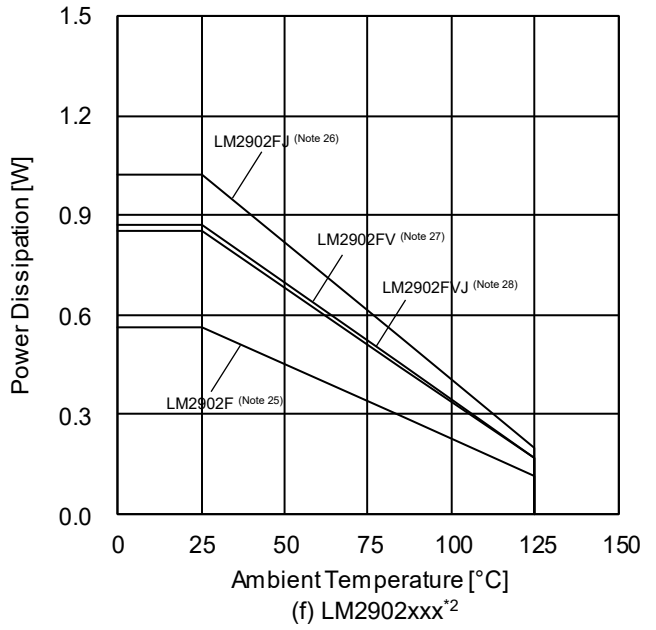
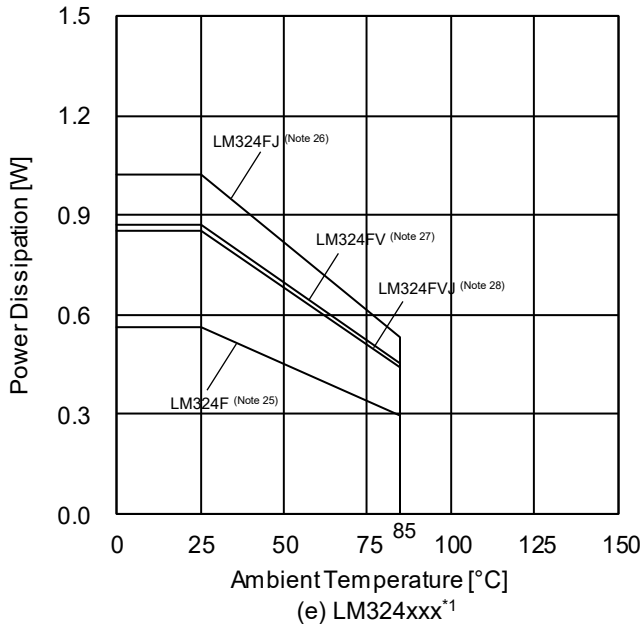

*1 Last Time Buy.
*2 Partial Last Time Buy.

Note 21	Note 22	Note 23	Note 24	Note 25	Note 26	Note 27	Note 28	Unit
5.5	5.4	5.0	4.7	4.5	8.2	7.0	6.8	mW/°C

When using the unit above $T_A=25^\circ\text{C}$, subtract the value above per Celsius degree.
Power dissipation is the value when FR4 glass epoxy board 70mm × 70mm × 1.6mm (copper foil area below 3%) is mounted.

Figure 67. Thermal Resistance and Derating Curve

Operational Notes

1. Reverse Connection of Power Supply

Connecting the power supply in reverse polarity can damage the IC. Take precautions against reverse polarity when connecting the power supply, such as mounting an external diode between the power supply and the IC's power supply pins.

2. Power Supply Lines

Design the PCB layout pattern to provide low impedance supply lines. Separate the ground and supply lines of the digital and analog blocks to prevent noise in the ground and supply lines of the digital block from affecting the analog block. Furthermore, connect a capacitor to ground at all power supply pins. Consider the effect of temperature and aging on the capacitance value when using electrolytic capacitors.

3. Ground Voltage

Ensure that no pins are at a voltage below that of the ground pin at any time, even during transient condition.

4. Ground Wiring Pattern

When using both small-signal and large-current ground traces, the two ground traces should be routed separately but connected to a single ground at the reference point of the application board to avoid fluctuations in the small-signal ground caused by large currents. Also ensure that the ground traces of external components do not cause variations on the ground voltage. The ground lines must be as short and thick as possible to reduce line impedance.

5. Thermal Consideration

Should by any chance the power dissipation rating be exceeded the rise in temperature of the chip may result in deterioration of the properties of the chip. The absolute maximum rating of the P_D stated in this specification is when the IC is mounted on a 70mm x 70mm x 1.6mm glass epoxy board. In case of exceeding this absolute maximum rating, increase the board size and copper area to prevent exceeding the P_D rating.

6. Recommended Operating Conditions

These conditions represent a range within which the expected characteristics of the IC can be approximately obtained. The electrical characteristics are guaranteed under the conditions of each parameter.

7. In-rush Current

When power is first supplied to the IC, it is possible that the internal logic may be unstable and inrush current may flow instantaneously due to the internal powering sequence and delays, especially if the IC has more than one power supply. Therefore, give special consideration to power coupling capacitance, power wiring, width of ground wiring, and routing of connections.

8. Operation Under Strong Electromagnetic Field

Operating the IC in the presence of a strong electromagnetic field may cause the IC to malfunction.

9. Testing on Application Boards

When testing the IC on an application board, connecting a capacitor directly to a low-impedance output pin may subject the IC to stress. Always discharge capacitors completely after each process or step. The IC's power supply should always be turned off completely before connecting or removing it from the test setup during the inspection process. To prevent damage from static discharge, ground the IC during assembly and use similar precautions during transport and storage.

10. Inter-pin Short and Mounting Errors

Ensure that the direction and position are correct when mounting the IC on the PCB. Incorrect mounting may result in damaging the IC. Avoid nearby pins being shorted to each other especially to ground, power supply and output pin. Inter-pin shorts could be due to many reasons such as metal particles, water droplets (in very humid environment) and unintentional solder bridge deposited in between pins during assembly to name a few.

Operational Notes – continued

11. Regarding the Input Pin of the IC

This monolithic IC contains P+ isolation and P substrate layers between adjacent elements in order to keep them isolated. P-N junctions are formed at the intersection of the P layers with the N layers of other elements, creating a parasitic diode or transistor. For example (refer to figure below):

When $GND > Pin A$ and $GND > Pin B$, the P-N junction operates as a parasitic diode.
 When $GND > Pin B$, the P-N junction operates as a parasitic transistor.

Parasitic diodes inevitably occur in the structure of the IC. The operation of parasitic diodes can result in mutual interference among circuits, operational faults, or physical damage. Therefore, conditions that cause these diodes to operate, such as applying a voltage lower than the GND voltage to an input pin (and thus to the P substrate) should be avoided.

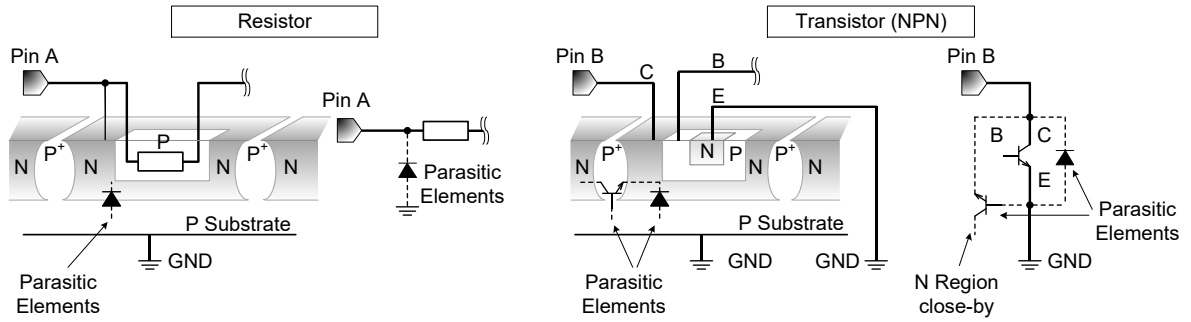
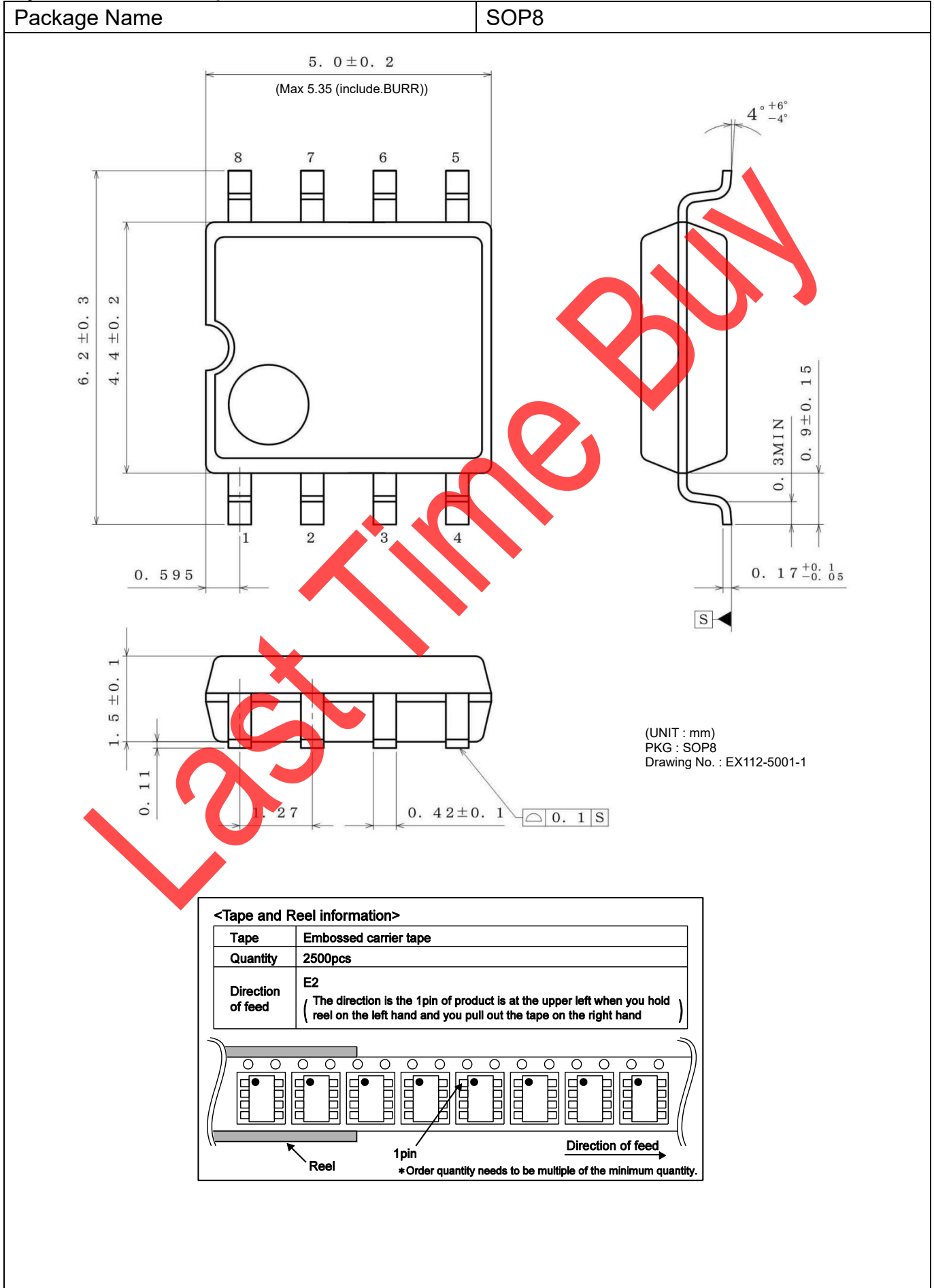
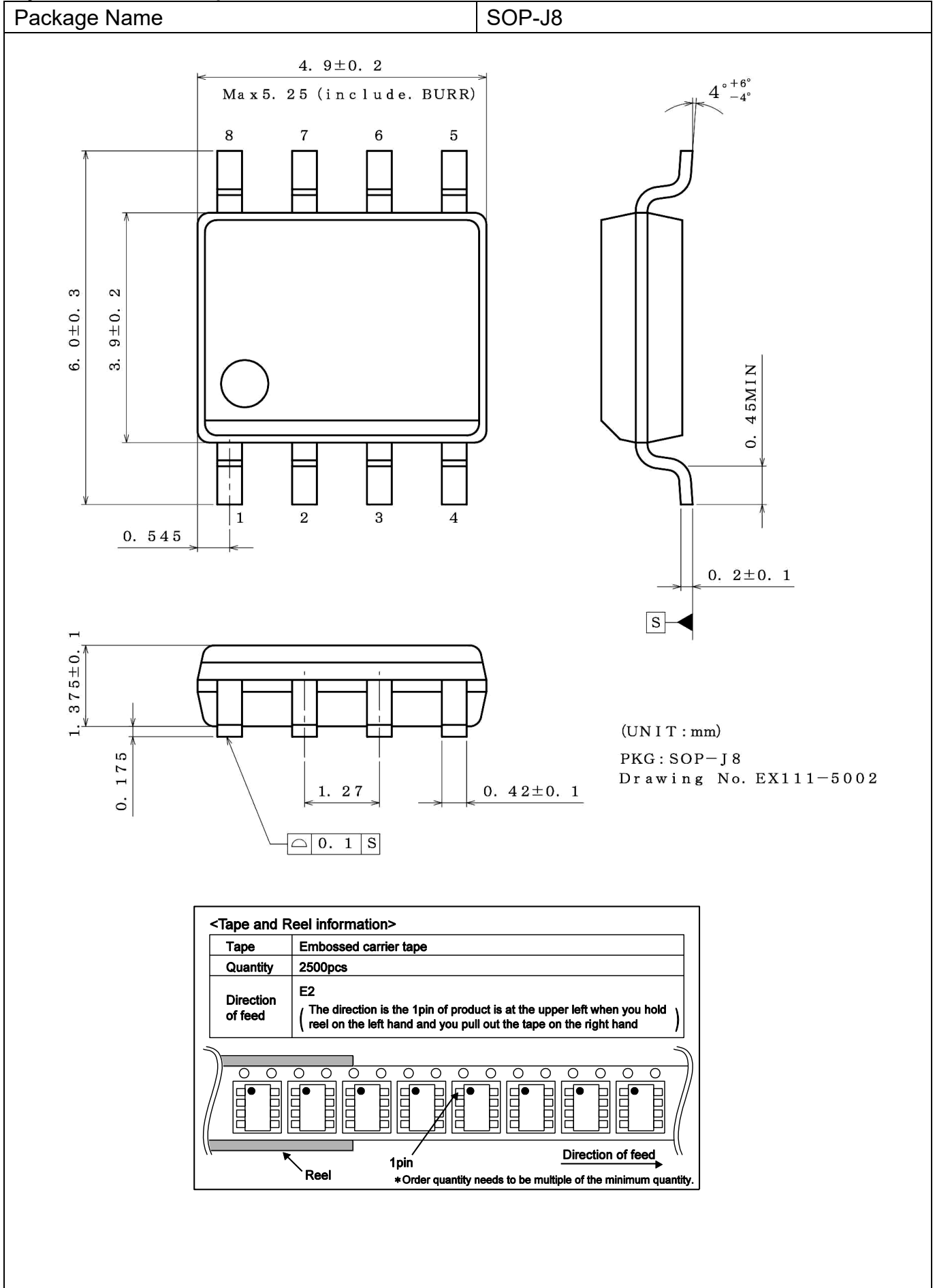

Figure 68. Example of monolithic IC structure

Physical Dimensions, Tape and Reel Information



Physical Dimensions, Tape and Reel Information – continued



Physical Dimensions, Tape and Reel Information – continued

Package Name	SSOP-B8
--------------	---------

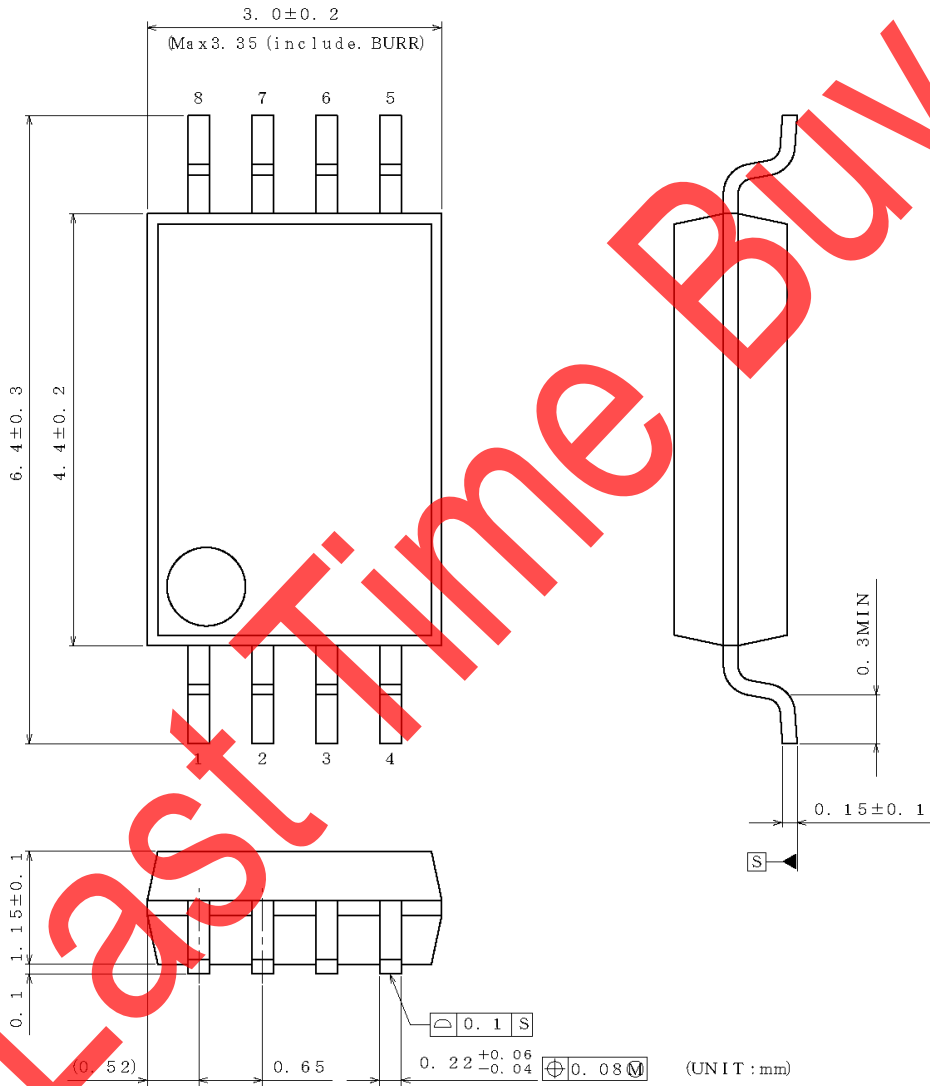

PKG: SSOP-B8
Drawing No. EX151-5002

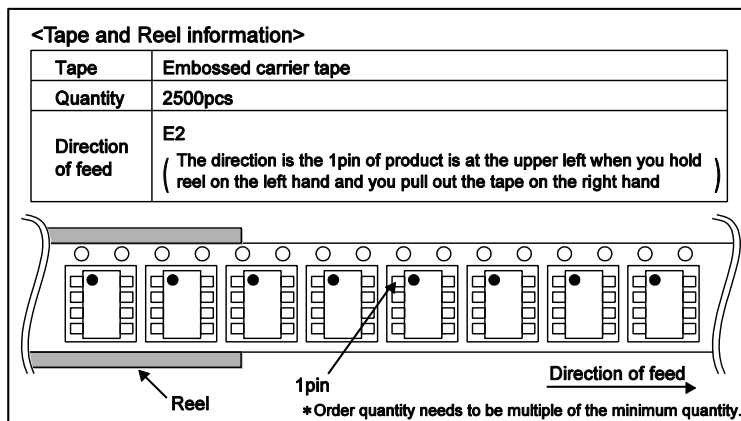

Physical Dimensions, Tape and Reel Information – continued

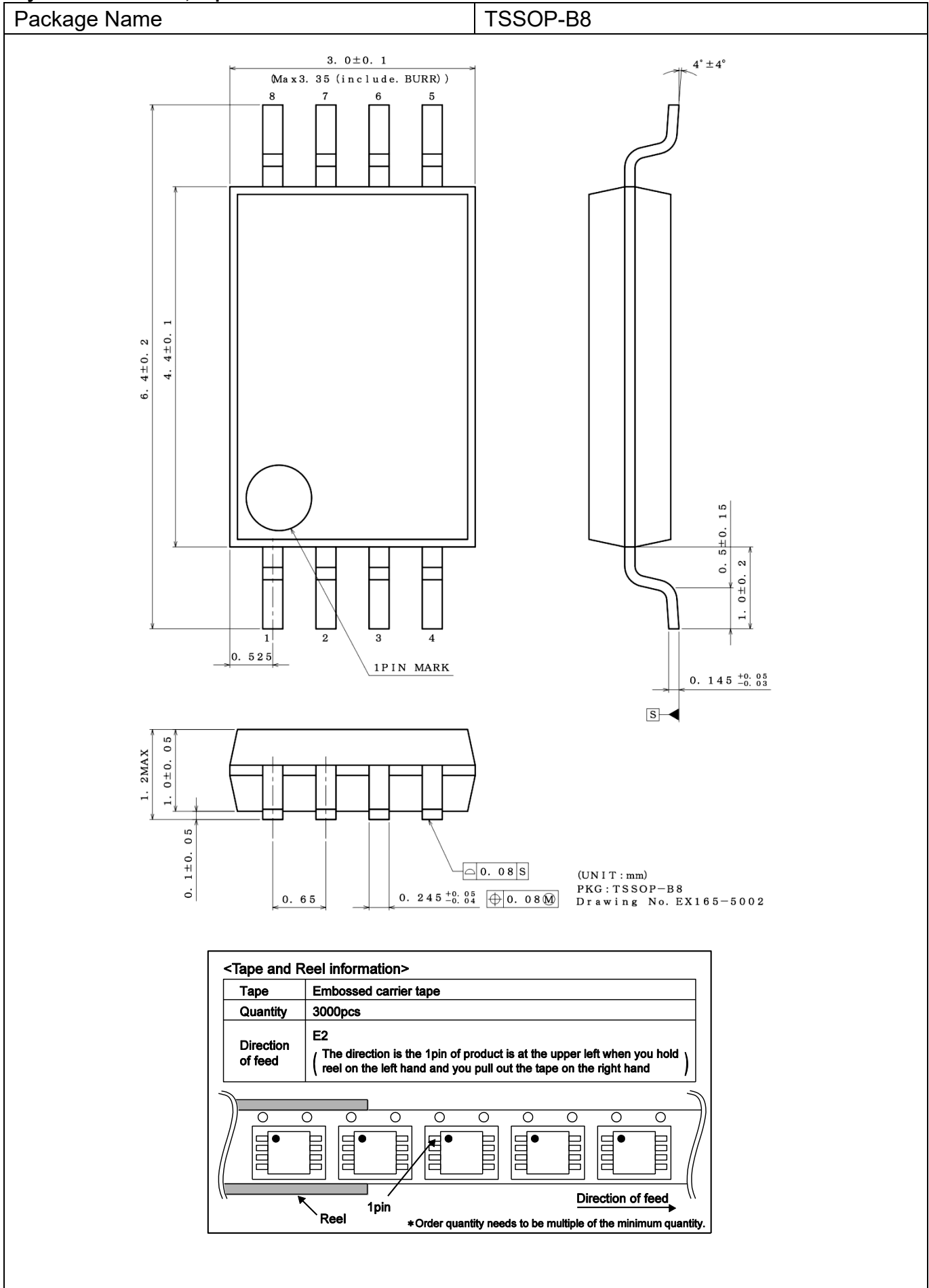

Physical Dimensions, Tape and Reel Information – continued

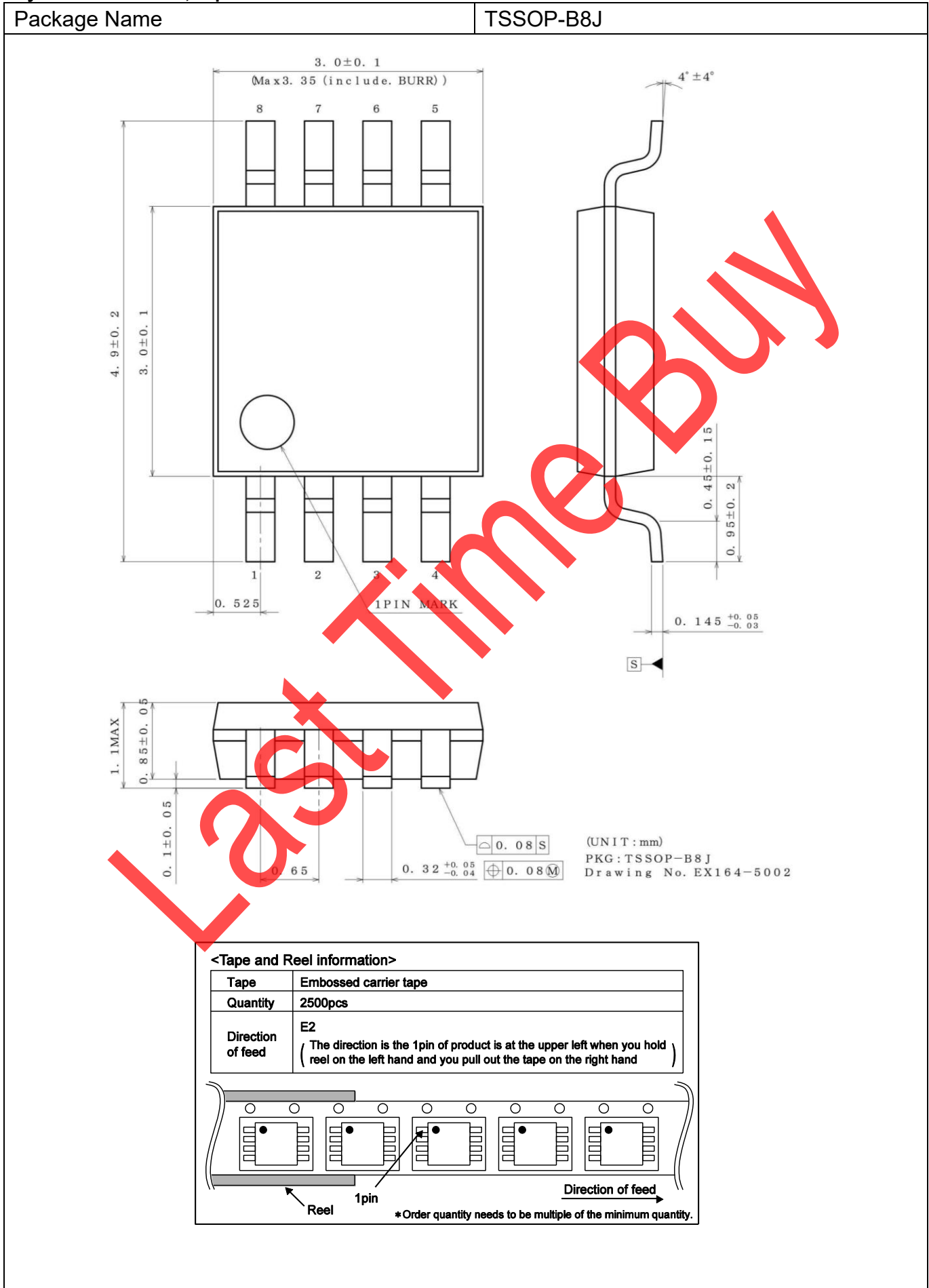

Physical Dimensions, Tape and Reel Information – continued

Package Name	MSOP8
--------------	-------

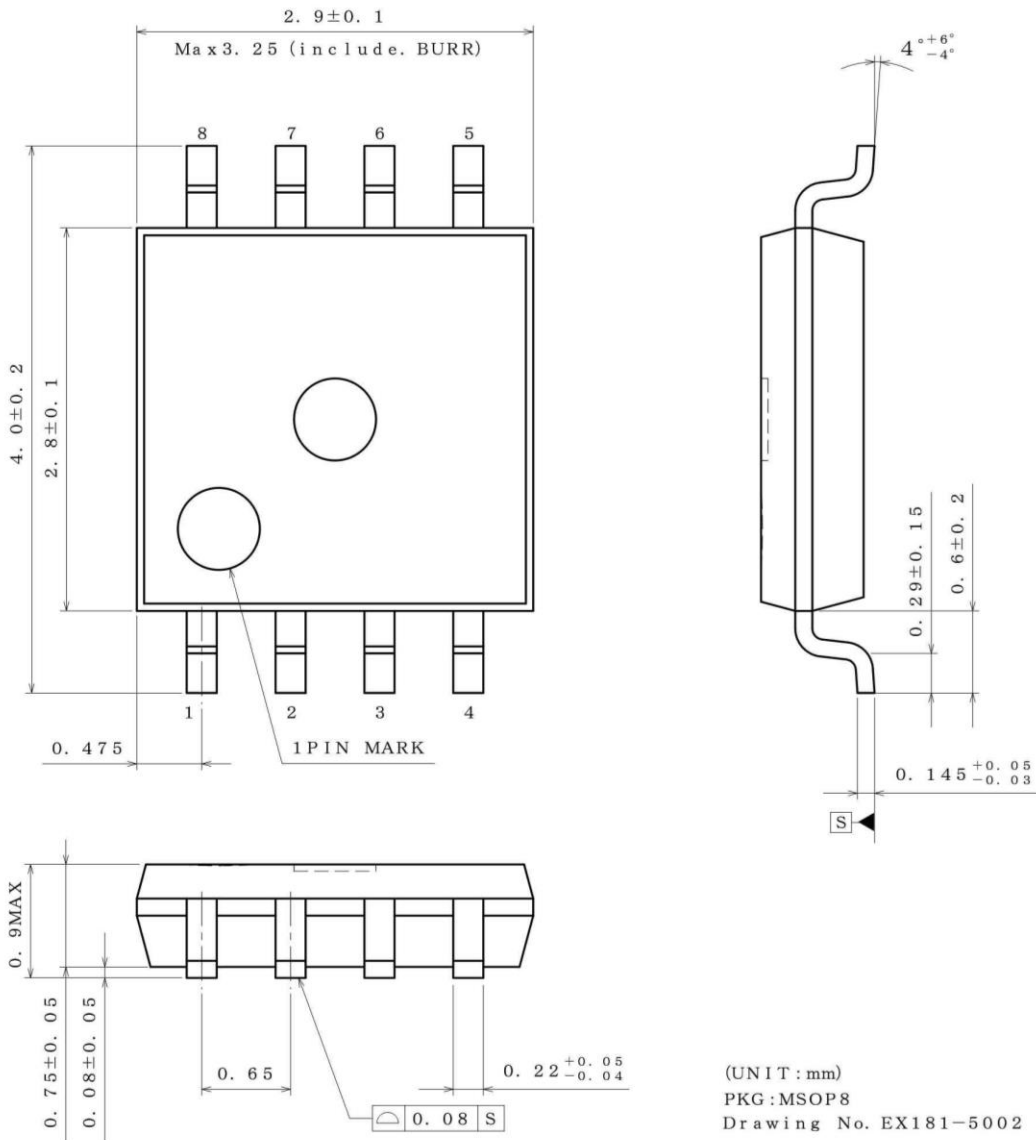

<Tape and Reel information>

Tape	Embossed carrier tape
Quantity	3000pcs
Direction of feed	TR (The direction is the 1pin of product is at the upper right when you hold reel on the left hand and you pull out the tape on the right hand)

***Order quantity needs to be multiple of the minimum quantity.**

Physical Dimensions, Tape and Reel Information – continued

Package Name	SOP14
--------------	-------

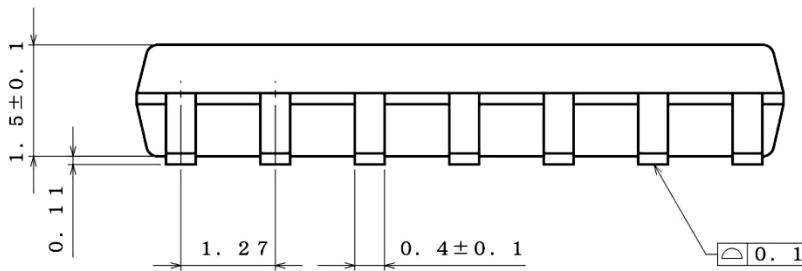
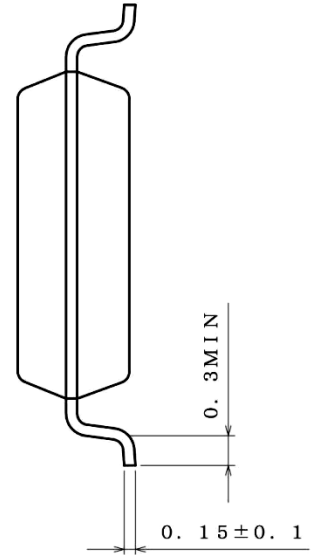
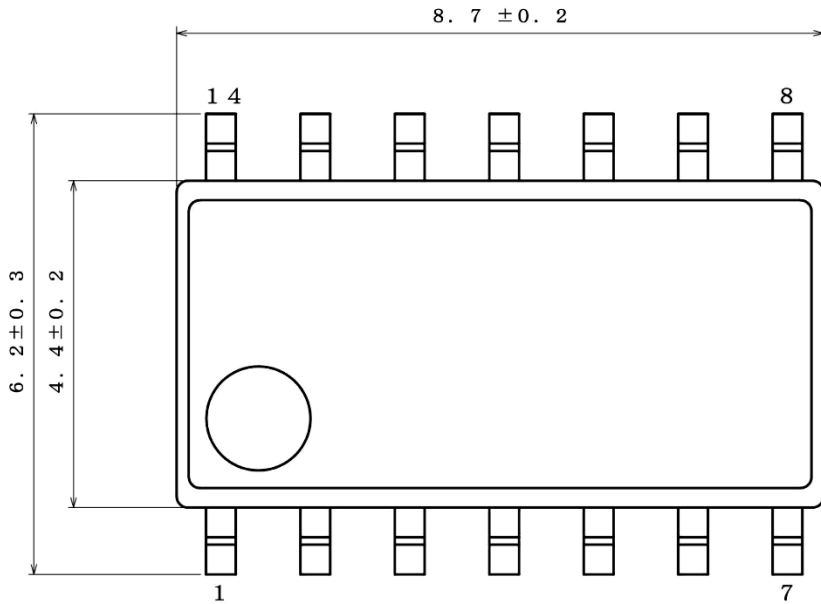

(UNIT : mm)
 PKG : SOP14
 Drawing No. : EX113-5001

<Tape and Reel information>

Tape	Embossed carrier tape
Quantity	2500pcs
Direction of feed	E2 (The direction is the 1pin of product is at the upper left when you hold reel on the left hand and you pull out the tape on the right hand)

Physical Dimensions, Tape and Reel Information – continued

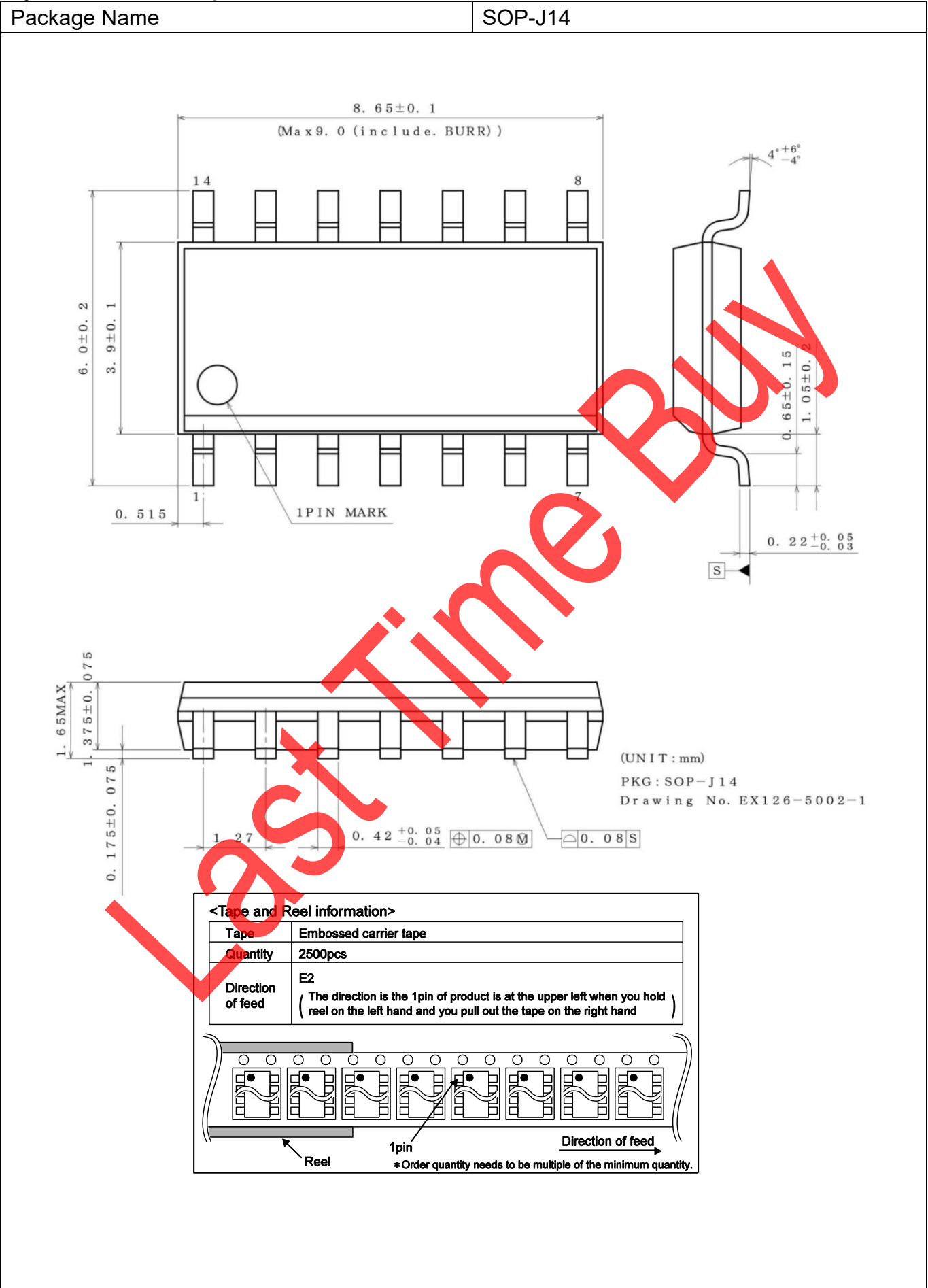

Physical Dimensions, Tape and Reel Information – continued

Package Name	SSOP-B14
--------------	----------

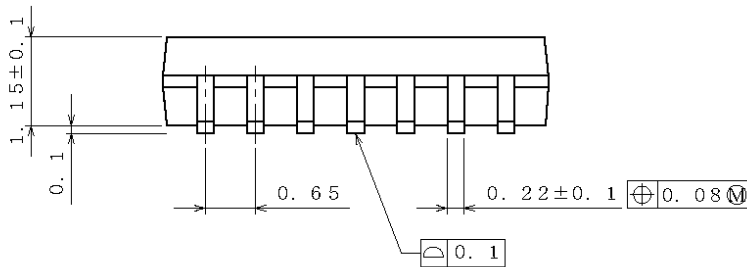
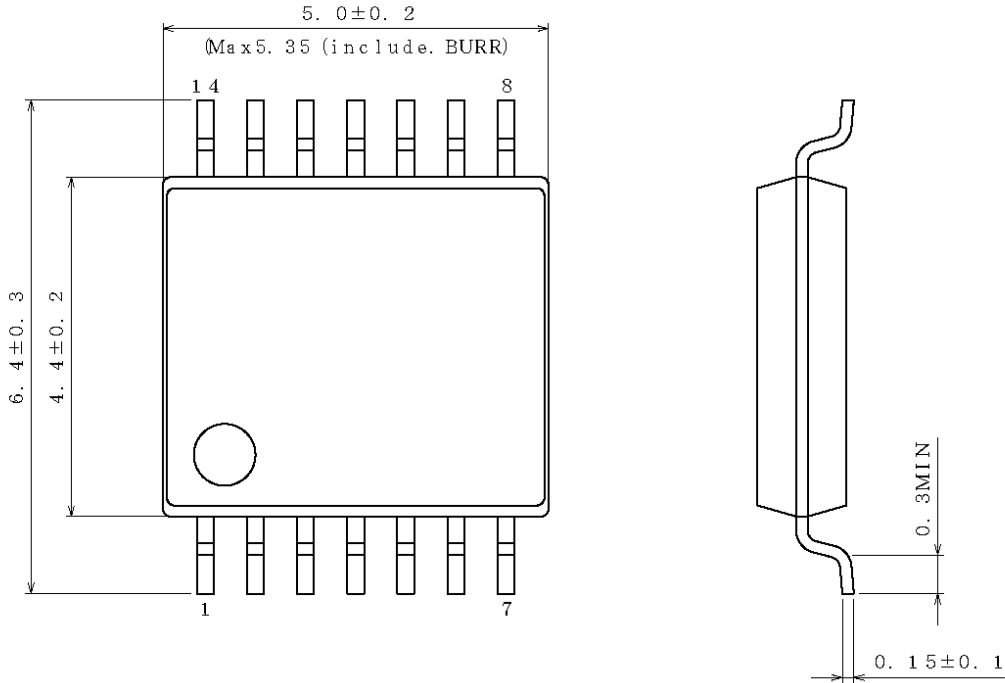

(UNIT : mm)
 PKG : SSOP-B14
 Drawing No. EX152-5002

<Tape and Reel information>

Tape	Embossed carrier tape
Quantity	2500pcs
Direction of feed	E2 (The direction is the 1pin of product is at the upper left when you hold reel on the left hand and you pull out the tape on the right hand)

Reel 1pin Direction of feed

*Order quantity needs to be multiple of the minimum quantity.

Physical Dimensions, Tape and Reel Information – continued

Package Name	TSSOP-B14J
--------------	------------

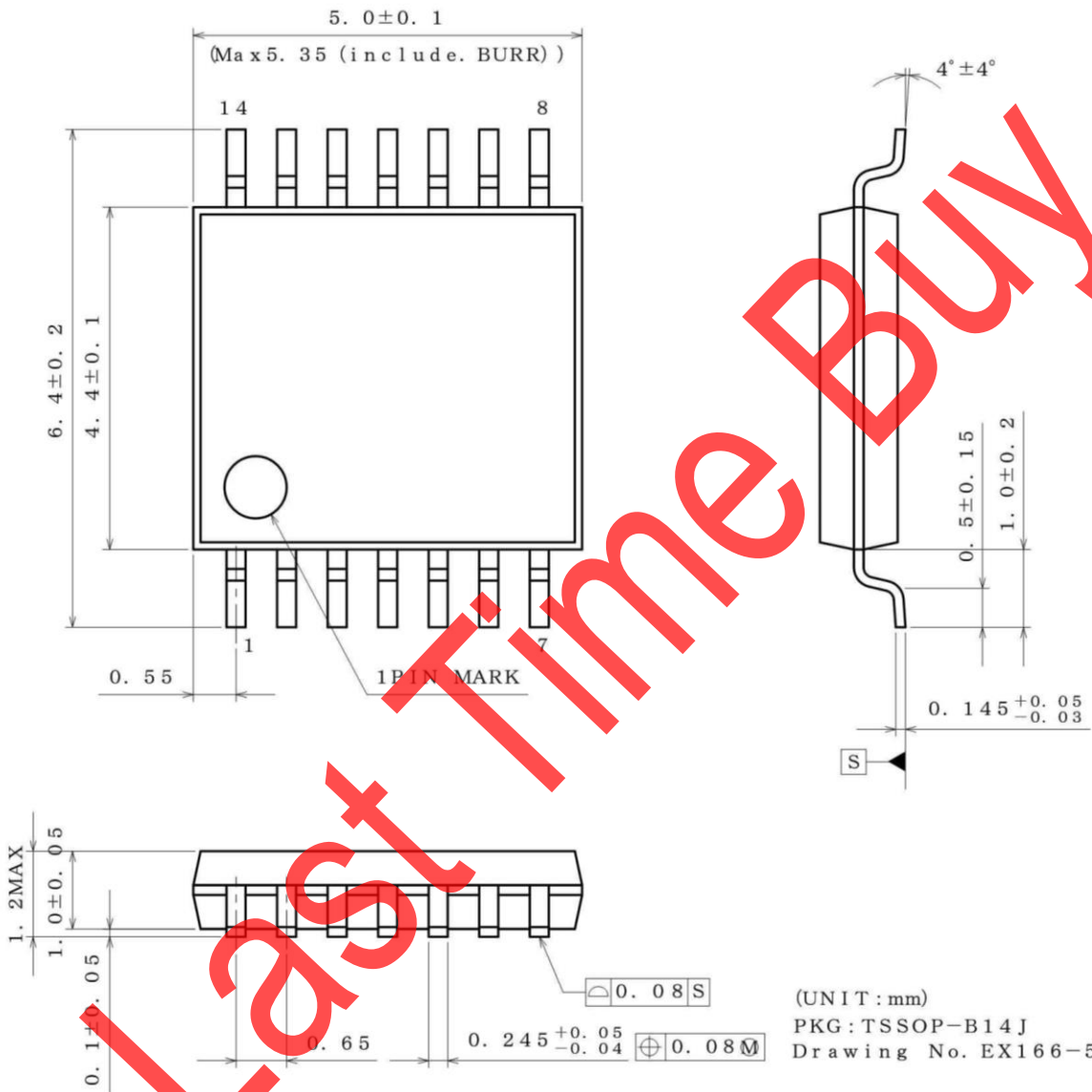

<Tape and Reel information>

Tape	Embossed carrier tape
Quantity	2500pcs
Direction of feed	E2 (The direction is the 1pin of product is at the upper left when you hold reel on the left hand and you pull out the tape on the right hand)

* Order quantity needs to be multiple of the minimum quantity.

Ordering Information

L M X X X X X X	-	X X X	
Part Number	Package	Manufacturing Code	Packaging and forming specification
LM358F ^{*1}	F : SOP8 ^{*1}	G	E2: Embossed tape and reel
LM358FJ ^{*1}	: SOP14 ^{*2}	LM2904FVM	(SOP8/SOP-J8/SSOP-B8/ TSSOP-B8/ SOP14/SOP-J14/ SSOP-B14/TSSOP-B14J)
LM358FV ^{*1}	FJ : SOP-J8 ^{*2}	only	TR: Embossed tape and reel
LM358FVT ^{*1}	: SOP-J14 ^{*1}		(MSOP8)
LM358FVJ ^{*1}	FV : SSOP-B8 ^{*1}		
LM358FVM ^{*1}	: SSOP-B14 ^{*2}		
LM324F ^{*1}	FVT : TSSOP-B8 ^{*2}		
LM324FJ ^{*1}	FVJ : TSSOP-B8J ^{*1}		
LM324FV ^{*1}	: TSSOP-B14J ^{*1}		
LM324FVJ ^{*1}	FVM : MSOP8 ^{*2}		
LM2904F ^{*1}			
LM2904FJ			
LM2904FV ^{*1}			
LM2904FVT			
LM2904FVJ ^{*1}			
LM2904FVM			
LM2902F			
LM2902FJ ^{*1}			
LM2902FV			
LM2902FVJ ^{*1}			

^{*1} Last Time Buy.
^{*2} Partial Last Time Buy.

Line-up

Operating Temperature Range	Channel	Package		Orderable Part Number
-40°C to +85°C	2ch	SOP8	Reel of 2500	LM358F-E2 ^{*1}
		SOP-J8	Reel of 2500	LM358FJ-E2 ^{*1}
		SSOP-B8	Reel of 2500	LM358FV-E2 ^{*1}
		TSSOP-B8	Reel of 3000	LM358FVT-E2 ^{*1}
		TSSOP-B8J	Reel of 2500	LM358FVJ-E2 ^{*1}
		MSOP8	Reel of 3000	LM358FVM-TR ^{*1}
	4ch	SOP14	Reel of 2500	LM324F-E2 ^{*1}
		SOP-J14	Reel of 2500	LM324FJ-E2 ^{*1}
		SSOP-B14	Reel of 2500	LM324FV-E2 ^{*1}
		TSSOP-B14J	Reel of 2500	LM324FVJ-E2 ^{*1}
-40°C to +125°C	2ch	SOP8	Reel of 2500	LM2904F-E2 ^{*1}
		SOP-J8	Reel of 2500	LM2904FJ-E2
		SSOP-B8	Reel of 2500	LM2904FV-E2 ^{*1}
		TSSOP-B8	Reel of 3000	LM2904FVT-E2
		TSSOP-B8J	Reel of 2500	LM2904FVJ-E2 ^{*1}
		MSOP8	Reel of 3000	LM2904FVM-GTR
	4ch	SOP14	Reel of 2500	LM2902F-E2
		SOP-J14	Reel of 2500	LM2902FJ-E2 ^{*1}
		SSOP-B14	Reel of 2500	LM2902FV-E2
		TSSOP-B14J	Reel of 2500	LM2902FVJ-E2 ^{*1}

^{*1} Last Time Buy.

Marking Diagram

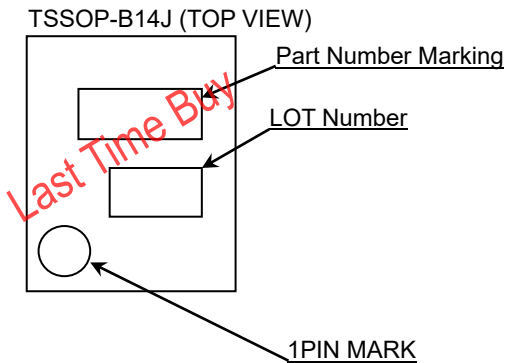
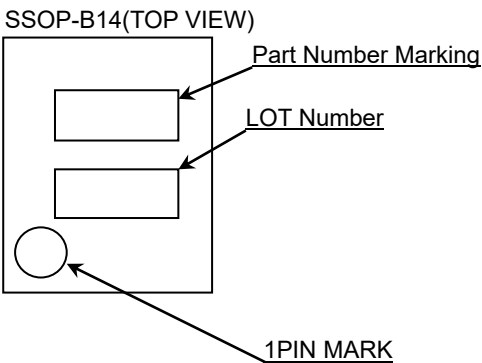
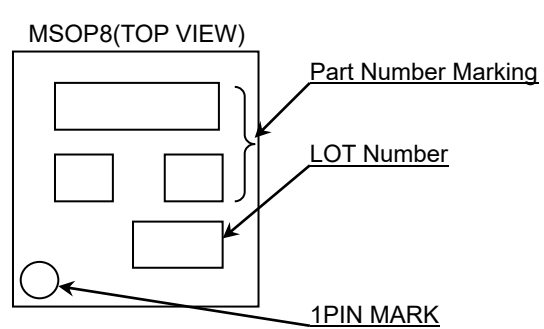
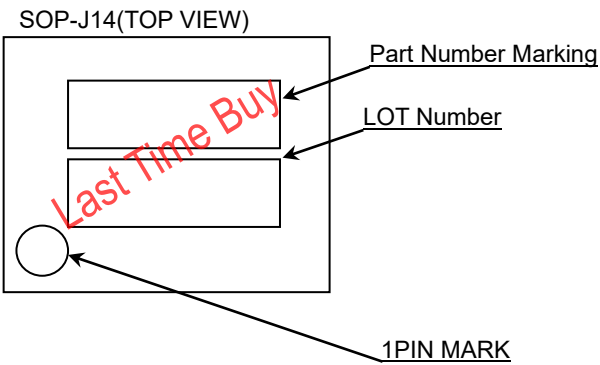
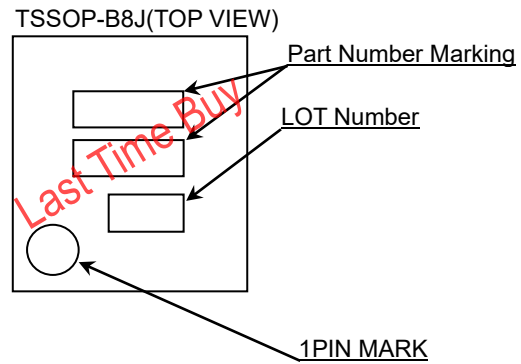
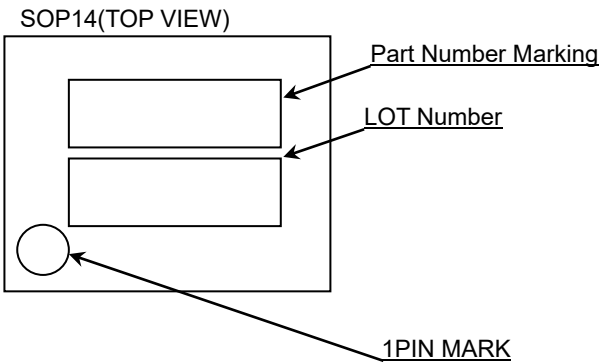
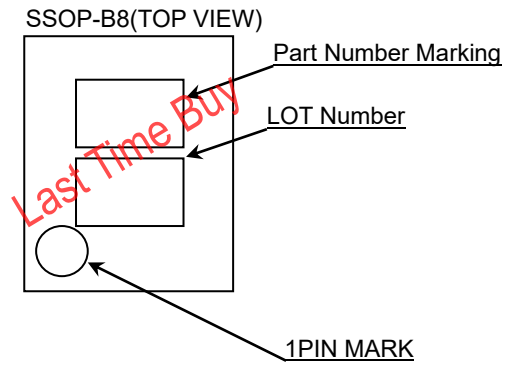
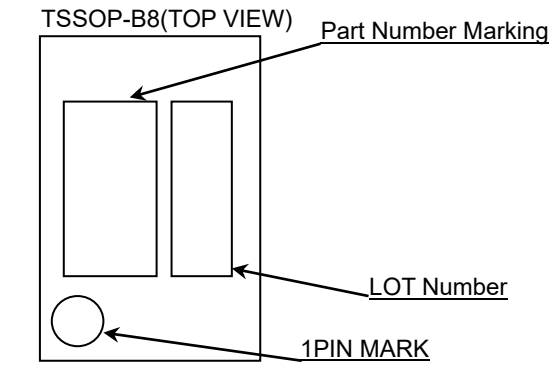
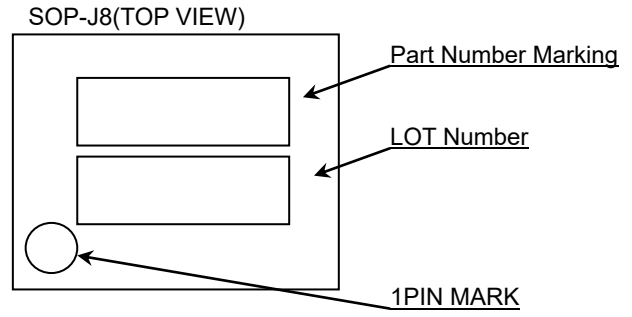
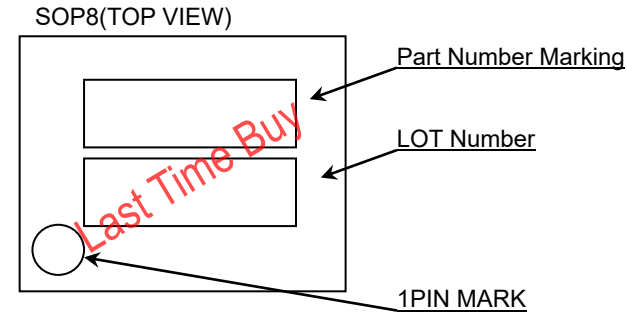

Marking Diagram – continued

Product Name		Package Type	Marking
LM358*1	F*1	SOP8	358L
	FJ*1	SOP-J8	
	FV*1	SSOP-B8	
	FVT*1	TSSOP-B8	
	FVJ*1	TSSOP-B8J	
	FVM*1	MSOP8	
LM324*1	F*1	SOP14	LM324F
	FJ*1	SOP-J14	LM324FJ
	FV*1	SSOP-B14	324L
	FVJ*1	TSSOP-B14J	
LM2904*2	F*1	SOP8	2904L
	FJ	SOP-J8	04L
	FV*1	SSOP-B8	
	FVT	TSSOP-B8	2904L
	FVJ*1	TSSOP-B8J	
	FVM	MSOP8	
LM2902*2	F	SOP14	LM2902F
	FJ*1	SOP-J14	LM2902FJ
	FV	SSOP-B14	2902L
	FVJ*1	TSSOP-B14J	

*1 Last Time Buy.

*2 Partial Last Time Buy.

Revision History

Date	Revision	Changes
10.Jul.2015	001	New Release
09.Oct.2015	002	LM358FJ, LM358FV, LM358FVT, and LM324F are added
10.Feb.2016	003	LM2904xxx (F, FJ, FV, FVT, FVM, FVJ), and LM358xxx (FVM, FVJ) are added
06.Jun.2016	004	LM324xxx (FJ, FV, FVJ), and LM2902xxx (F, FJ, FV, FVJ) are added
01.Aug.2016	005	Correction of erroneous description (P.4 Icc Full Range 1.5→2.5mA) Delete Land Pattern Data(P.44)
11.Dec.2020	006	P.44-2, 44-3, Updated packages and part numbers.
09.Dec.2025	007	Added words for Not Recommended New Designs category product. Add an item for Output Current to the Absolute Maximum Ratings. Add the max limits for Output Source Current and Output Sink Current.
09.Apr.2026	008	Added watermarks and words for Last Time Buy category product.

Ordering Information

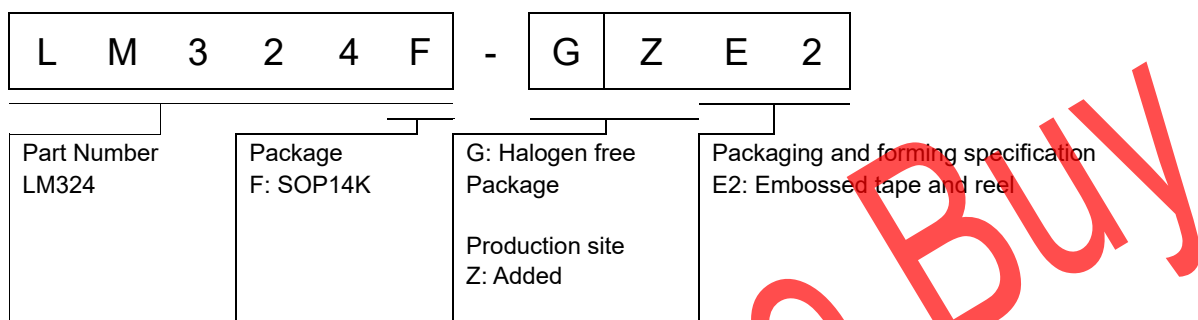

Marking Diagram

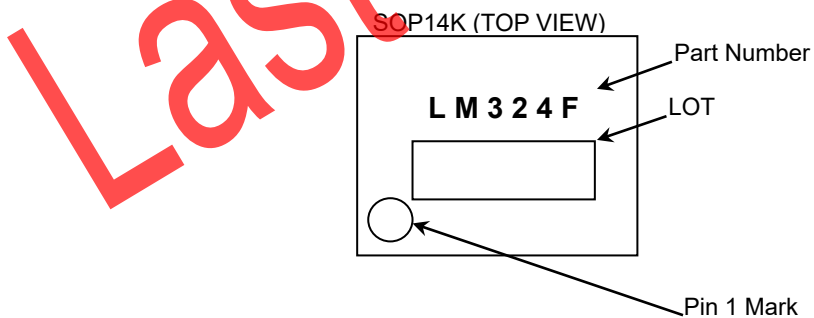

Physical Dimension and Packing Information

Package Name	SOP14K
--------------	--------

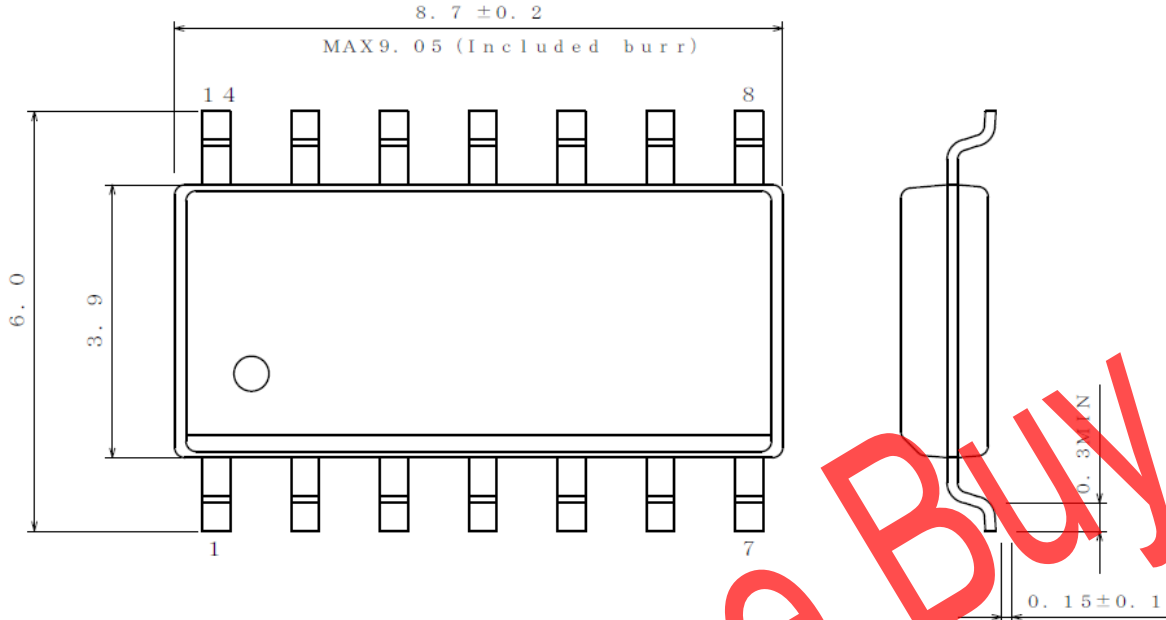

Last Time Buy

(UNIT : mm)

PKG : SOP14K

Drawing No. : EX001-0105

< Tape and Reel Information >

Tape	Embossed carrier tape
Quantity	2500pcs
Direction of feed	E2 The direction is the pin 1 of product is at the upper left when you hold reel on the left hand and you pull out the tape on the right hand

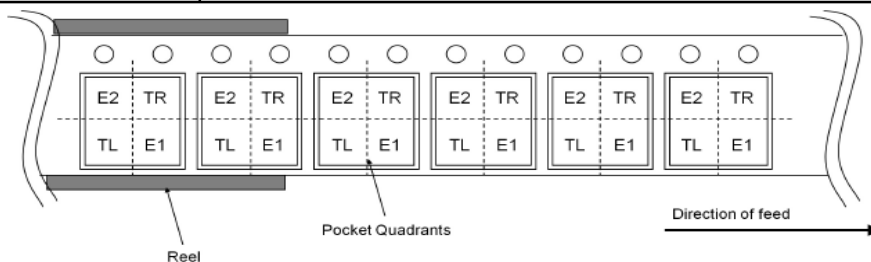

Notice

Precaution on using ROHM Products

- Our Products are designed and manufactured for application in ordinary electronic equipments (such as AV equipment, OA equipment, telecommunication equipment, home electronic appliances, amusement equipment, etc.). If you intend to use our Products in devices requiring extremely high reliability (such as medical equipment ^(Note 1), transport equipment, traffic equipment, aircraft/spacecraft, nuclear power controllers, fuel controllers, car equipment including car accessories, safety devices, etc.) and whose malfunction or failure may cause loss of human life, bodily injury or serious damage to property ("Specific Applications"), please consult with the ROHM sales representative in advance. Unless otherwise agreed in writing by ROHM in advance, ROHM shall not be in any way responsible or liable for any damages, expenses or losses incurred by you or third parties arising from the use of any ROHM's Products for Specific Applications.

(Note1) Medical Equipment Classification of the Specific Applications

JAPAN	USA	EU	CHINA
CLASS III	CLASS III	CLASS II b	CLASS III
CLASS IV		CLASS III	

- ROHM designs and manufactures its Products subject to strict quality control system. However, semiconductor products can fail or malfunction at a certain rate. Please be sure to implement, at your own responsibilities, adequate safety measures including but not limited to fail-safe design against the physical injury, damage to any property, which a failure or malfunction of our Products may cause. The following are examples of safety measures:
 - Installation of protection circuits or other protective devices to improve system safety
 - Installation of redundant circuits to reduce the impact of single or multiple circuit failure
- Our Products are designed and manufactured for use under standard conditions and not under any special or extraordinary environments or conditions, as exemplified below. Accordingly, ROHM shall not be in any way responsible or liable for any damages, expenses or losses arising from the use of any ROHM's Products under any special or extraordinary environments or conditions. If you intend to use our Products under any special or extraordinary environments or conditions (as exemplified below), your independent verification and confirmation of product performance, reliability, etc. prior to use, must be necessary:
 - Use of our Products in any types of liquid, including water, oils, chemicals, and organic solvents
 - Use of our Products outdoors or in places where the Products are exposed to direct sunlight or dust
 - Use of our Products in places where the Products are exposed to sea wind or corrosive gases, including Cl₂, H₂S, NH₃, SO₂, and NO₂
 - Use of our Products in places where the Products are exposed to static electricity or electromagnetic waves
 - Use of our Products in proximity to heat-producing components, plastic cords, or other flammable items
 - Sealing or coating our Products with resin or other coating materials
 - Use of our Products without cleaning residue of flux (Exclude cases where no-clean type fluxes is used. However, recommend sufficiently about the residue.); or Washing our Products by using water or water-soluble cleaning agents for cleaning residue after soldering
 - Use of the Products in places subject to dew condensation
- The Products are not subject to radiation-proof design.
- Please verify and confirm characteristics of the final or mounted products in using the Products.
- In particular, if a transient load (a large amount of load applied in a short period of time, such as pulse. is applied, confirmation of performance characteristics after on-board mounting is strongly recommended. Avoid applying power exceeding normal rated power; exceeding the power rating under steady-state loading condition may negatively affect product performance and reliability.
- De-rate Power Dissipation depending on ambient temperature. When used in sealed area, confirm that it is the use in the range that does not exceed the maximum junction temperature.
- Confirm that operation temperature is within the specified range described in the product specification.
- ROHM shall not be in any way responsible or liable for failure induced under deviant condition from what is defined in this document.

Precaution for Mounting / Circuit board design

- When a highly active halogenous (chlorine, bromine, etc.) flux is used, the residue of flux may negatively affect product performance and reliability.
- In principle, the reflow soldering method must be used on a surface-mount products, the flow soldering method must be used on a through hole mount products. If the flow soldering method is preferred on a surface-mount products, please consult with the ROHM representative in advance.

For details, please refer to ROHM Mounting specification

Precautions Regarding Application Examples and External Circuits

1. If change is made to the constant of an external circuit, please allow a sufficient margin considering variations of the characteristics of the Products and external components, including transient characteristics, as well as static characteristics.
2. You agree that application examples, their constants, software, and associated data and information contained in this document are presented only as guidance for Products use. Therefore, in case you use such information, you are solely responsible for it and you must exercise your own independent verification and judgment in the use of such information contained in this document. ROHM shall not be in any way responsible or liable for any damages, expenses or losses incurred by you or third parties arising from the use of such information.

Precaution for Electrostatic

This Product is electrostatic sensitive product, which may be damaged due to electrostatic discharge. Please take proper caution in your manufacturing process and storage so that voltage exceeding the Products maximum rating will not be applied to Products. Please take special care under dry condition (e.g. Grounding of human body / equipment / solder iron, isolation from charged objects, setting of Ionizer, friction prevention and temperature / humidity control).

Precaution for Storage / Transportation

1. Product performance and soldered connections may deteriorate if the Products are stored in the places where:
 - [a] the Products are exposed to sea winds or corrosive gases, including Cl₂, H₂S, NH₃, SO₂, and NO₂
 - [b] the temperature or humidity exceeds those recommended by ROHM
 - [c] the Products are exposed to direct sunshine or condensation
 - [d] the Products are exposed to high Electrostatic
2. Even under ROHM recommended storage condition, solderability of products out of recommended storage time period may be degraded. It is strongly recommended to confirm solderability before using Products of which storage time is exceeding the recommended storage time period.
3. Store / transport cartons in the correct direction, which is indicated on a carton with a symbol. Otherwise bent leads may occur due to excessive stress applied when dropping of a carton.
4. Use Products within the specified time after opening a humidity barrier bag. Baking is required before using Products of which storage time is exceeding the recommended storage time period.

Precaution for Product Label

A two-dimensional barcode printed on ROHM Products label is for ROHM's internal use only.

Precaution for Disposition

When disposing Products please dispose them properly using an authorized industry waste company.

Precaution for Foreign Exchange and Foreign Trade act

Since concerned goods might be fallen under listed items of export control prescribed by Foreign exchange and Foreign trade act, please consult with ROHM in case of export.

Precaution Regarding Intellectual Property Rights

1. All information and data including but not limited to application example contained in this document is for reference only. ROHM does not warrant that foregoing information or data will not infringe any intellectual property rights or any other rights of any third party regarding such information or data.
2. ROHM shall not have any obligations where the claims, actions or demands arising from the combination of the Products with other articles such as components, circuits, systems or external equipment (including software).
3. No license, expressly or implied, is granted hereby under any intellectual property rights or other rights of ROHM or any third parties with respect to the Products or the information contained in this document. Provided, however, that ROHM will not assert its intellectual property rights or other rights against you or your customers to the extent necessary to manufacture or sell products containing the Products, subject to the terms and conditions herein.

Other Precaution

1. This document may not be reprinted or reproduced, in whole or in part, without prior written consent of ROHM.
2. The Products may not be disassembled, converted, modified, reproduced or otherwise changed without prior written consent of ROHM.
3. In no event shall you use in any way whatsoever the Products and the related technical information contained in the Products or this document for any military purposes, including but not limited to, the development of mass-destruction weapons.
4. The proper names of companies or products described in this document are trademarks or registered trademarks of ROHM, its affiliated companies or third parties.

General Precaution

1. All information contained in this document is current as of the issuing date and subject to change without any prior notice. Before purchasing or using ROHM's Products, please confirm the latest information with a ROHM sales representative.
2. The information contained in this document is provided on an "as is" basis and ROHM does not warrant that all information contained in this document is accurate and/or error-free. ROHM shall not be in any way responsible or liable for any damages, expenses or losses incurred by you or third parties resulting from inaccuracy or errors of or concerning such information.

General Precaution

1. Before you use our Products, you are requested to carefully read this document and fully understand its contents. ROHM shall not be in any way responsible or liable for failure, malfunction or accident arising from the use of any ROHM's Products against warning, caution or note contained in this document.
2. All information contained in this document is current as of the issuing date and subject to change without any prior notice. Before purchasing or using ROHM's Products, please confirm the latest information with a ROHM sales representative.
3. The information contained in this document is provided on an "as is" basis and ROHM does not warrant that all information contained in this document is accurate and/or error-free. ROHM shall not be in any way responsible or liable for any damages, expenses or losses incurred by you or third parties resulting from inaccuracy or errors of or concerning such information.