

CONTACT ARRANGEMENT

REV	DESCRIPTION OF REVISIONS	DATE	DRAWN	CHECKED
A	FIRST RELEASE	02/19/2001	ST Ling	H Shen
B	CONTACT MATERIAL CHANGE	01/18/2005	ST Ling	H Shen

NOTES:

- ① CONNECTOR MEETS REQUIREMENT OF IEC 61076-4-101
- ② MATERIAL :
-HOUSING: GLASS-FILLED PBT, COLOR GREY, UL94V-0
-CONTACTS: COPPER ALLOY
- ③ CONTACT DIMENSION

	MATING	TERMINATION
LENGTH /	WIDTH x THICKNESS	LENGTH
A : 5.3 / 0.4	~ 0.50 x 0.4 ~ 0.36	3.7
C : 8.3 / 0.4	~ 0.50 x 0.4 ~ 0.36	3.7
- ④ CONTACT FINISH
30u"(0.75um) GOLD PLATING ON MATING AREA, TIN PLATING ON TAIL AREA, FLASH GOLD PLATING ON NON-MATING AREA, NICKEL UNDERPLATE ALLOVER
- ⑤ CONNECTOR PRINTED WITH COMPANY NAME, PART NUMBER, AND BATCH NUMBER

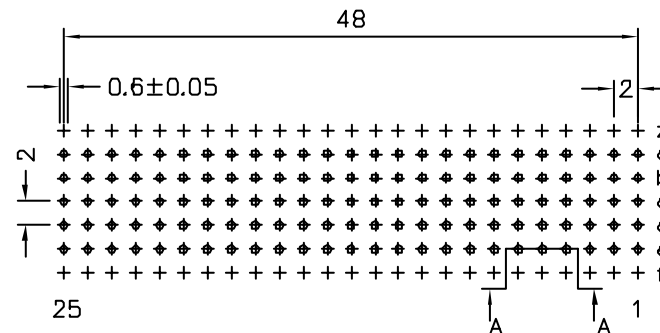
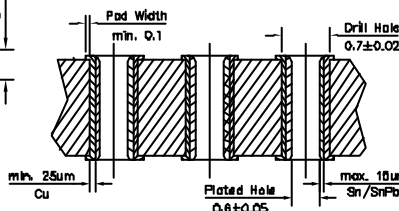
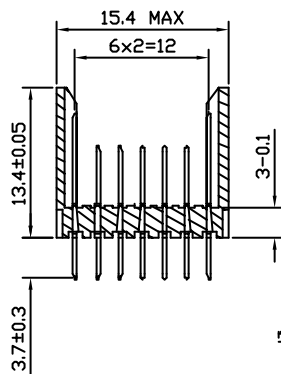
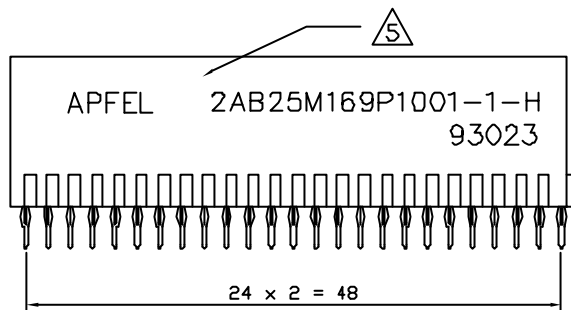
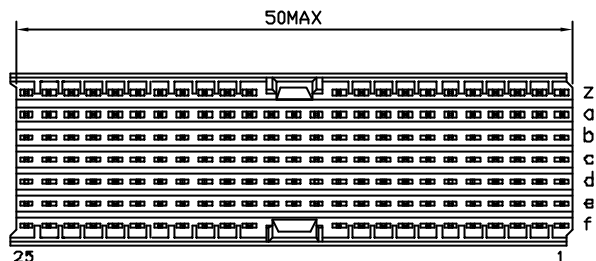
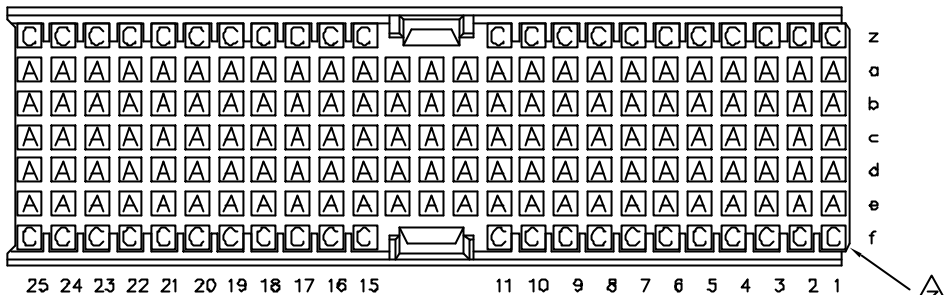

RECOMMENDED HOLE SPECIFICATIONS
SECTION A-A
SCALE 6 : 1

RECOMMENDED PCB HOLE LAYOUT
COMPONENT SIDE
SCALE 1.5 : 1

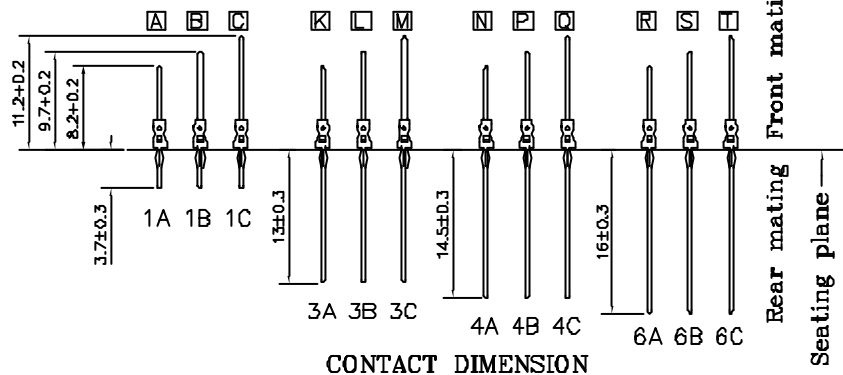

DESCRIPTION : 2.0mm MALE, TYPE AB25		APFEL		MILLIMETRE	
CUSTOMER DRAWING				X.XXX	±0.012
PART NUMBER		X.XX	±0.05		
No. 1 2AB25M169P1001-1-H		X.X	±0.1		
		X	±0.25		
DRAWN		UNITS	ANGLE		
ST Ling		mm	±1°		
CHECKED		SCALE	REV		
H Shen		1.4:1	B		
		DRAWING NO.			
		FO19D.DWG			

Vertical Male Type AB25 Connectors for Fix Boards

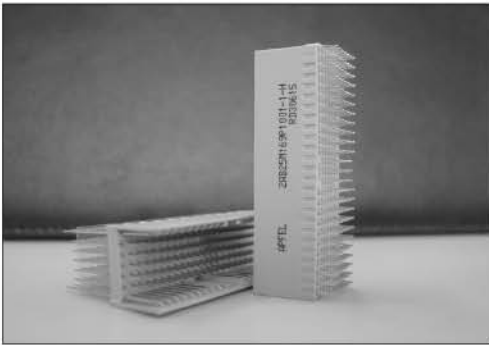

Type AB25 vertical male connector provides 125 signal contacts and optional 44 shielding contacts respectively in 5 + 2 row X 25 position configuration. All are end to end stackable without change in contact pitch.

Dimensions

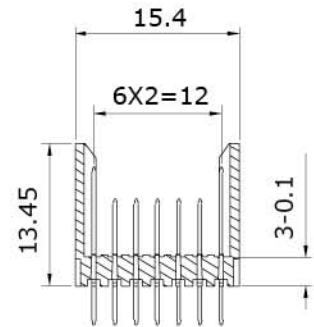
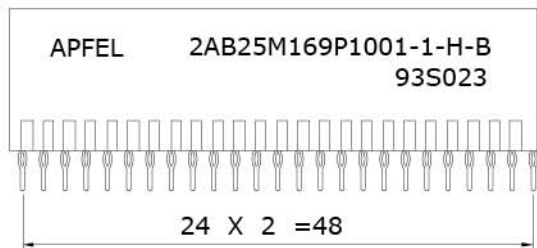
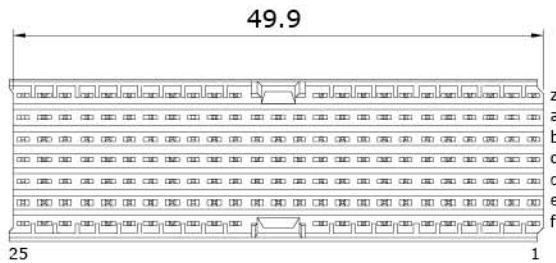

Recommended P.C.B. layout

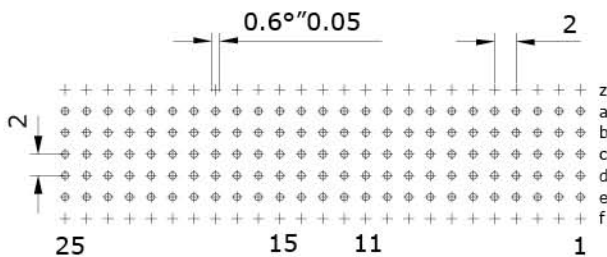

Dimensions shown are for reference purpose only. All dimensions are in millimeters unless otherwise specified.

Vertical Male Type AB25 Connectors for Fix Boards

Product Information

Assembly Drawing	Total Number	Row	Type	Part Numbers
	125	z a b c d e f	— 1A 1A 1A 1A 1A —	2AB25M125P1001-0-H-B
	125	z a b c d e f	— 1B 1B 1B 1B 1B —	2AB25M125P1002-0-H-B
	169	z a b c d e f	1C 1A 1A 1A 1A 1A 1C	2AB25M169P1001-1-H-B
	169	z a b c d e f	1C 1B 1B 1B 1B 1B 1C	2AB25M169P1002-1-H-B

Male Contact Options

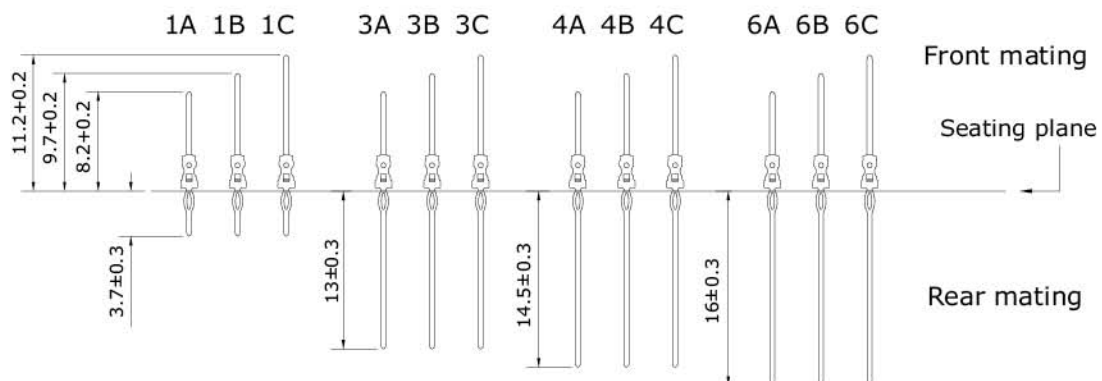

Dimensions shown are for reference purpose only. All dimensions are in millimeters unless otherwise specified.