

1.5mm or 2mm height contribute to smaller and thinner sets



TACT Switch™

Sharp Feeling

Soft Feeling

Snap-In Type

Surface Mount Type

Radial Type

■ Typical Specifications

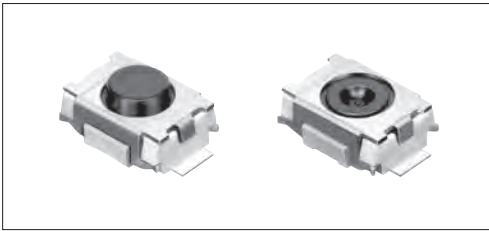

Items	Specifications
Rating (max.)	50mA 12V DC
Rating (min.)	10μA 1V DC
Travel (mm)	0.13

■ Product Line

Product No.	Operating force	Operating direction	Operating life (5mA 5V DC)	Initial contact resistance	Height	Minimum order unit (pcs.)		Drawing No.
						Japan	Export	
SKRKAHE020	0.98N	Top push	200,000 cycles	500mΩ max.	2mm	4,500	4,500	1
SKRKAEE020	1.57N			100mΩ max.				
SKRKAGE020				1.5mm	5,000	5,000	2	

■ Packing Specifications

Taping

Series	Number of packages (pcs.)			Tape width (mm)	Export package measurements (mm)
	1 reel	1 case /Japan	1 case / export packing		
SKRKAH SKRKAH	4,500	45,000	45,000	12	395×395×205
SKRKAG	5,000	50,000	50,000		

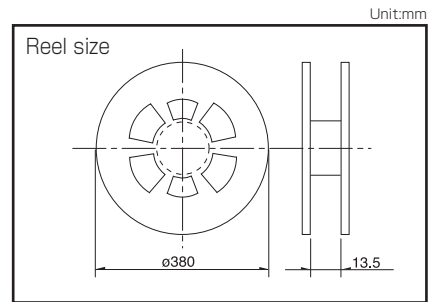

Note

For reels of 330mm diameter, please inquire.

■ Dimensions

No.	Photo	Style	PC board land dimensions (Viewed from switch mounting face)
1			

Refer to P.235 for soldering conditions.

■ Dimensions

Unit:mm

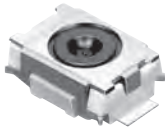
No.	Photo	Style	PC board land dimensions (Viewed from switch mounting face)
2			

■ Circuit Diagram

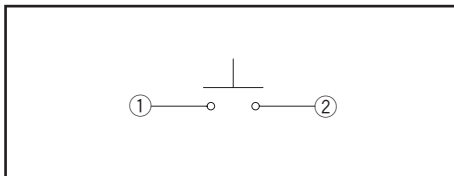

TACT Switch™

List of Varieties

TACT Switch™

















Sharp Feeling

Soft Feeling

Snap-In Type

Surface Mount Type

Radial Type

Type		Sharp Feeling Type							
		Surface Mount							
Series		SKRK	SKTH	SKRP	SKQM	SKQY	SKTQ	SKTR	SKSU
Photo									
Features		Compact size Low-profile	Compact size	High operation force Compact size	Compact size		Middle travel		
Water-proof		—	—	—	—	—	—	—	●
Dustproof		—	●	—	—	—	—	—	●
IP standard		—	—	—	—	—	—	—	67 equivalent
Operating direction	Top push	●	●	●	●	●	●	●	●
	Side push	—	—	—	—	—	—	—	—
Dimensions (mm)	W	3.9	3.5	4.2	6	6.1	5.3	□6.1	5.3
	D	2.9	3.2		3.5	3.7	5.4		5.4
	H	1.5/2	1.8/2.5	2.5	4.3/5	2.5	4.25	4.1	3.85/4.34
Operation force coverage	1N max.	↕	↕	↕	↕	↕	↕	↕	↕
	1N to 2N	↕	↕	↕	↕	↕	↕	↕	↕
	2N to 3N	↕	↕	↕	↕	↕	↕	↕	↕
	3N to 4N	↕	↕	↕	↕	↕	↕	↕	↕
Travel (mm)		0.13	0.12	0.2	0.25		0.71	0.72	0.7/0.9
Ground terminal		—	—	—	—	○	—	—	—
Operating temperature range		-40°C to +85°C			-40°C to +90°C				
Automotive use		—	●	●	●	●	●	●	●
Life Cycle									
Electrical performance	Rating (max.) (Resistive load)	50mA 12V DC	25mA 16V DC	50mA 16V DC	50mA 12V DC		50mA 16V DC		
	Rating (min.) (Resistive load)	10μA 1V DC							
	Insulation resistance	100MΩ min. 100V DC 1min.							
	Voltage proof	250V AC 1min.	100V AC 1min.	250V AC 1min.					
Durability	Vibration	10 to 55 to 10Hz/min., the amplitude is 1.5mm for all the frequencies, in the 3 direction of X, Y and Z for 2 hours respectively							
	Lifetime	Shall be in accordance with individual specifications.							
Environmental performance	Cold	-40°C 96h		-40°C 1,000h	-40°C 96h		-40°C 1,000h		
	Dry heat	90°C 96h		90°C 1,000h	90°C 96h		90°C 1,000h		
	Damp heat	60°C, 90 to 95%RH 96h		60°C, 90 to 95%RH 1,000h	60°C, 90 to 95%RH 96h		60°C, 90 to 95%RH 1,000h		
Page		204	206	208	210	211	213	214	215

W : Width. The most outer dimension excluding terminal portion.
D : Depth. The most outer dimension excluding terminal portion.
H : Height. The minimum dimension if there are variances.

TACT Switch™ Soldering Conditions 235
TACT Switch™ Cautions 236

Notes

- The automotive operating temperature range to be individually discussed upon request.
- Indicates applicability to all products in the series, while ○ indicates applicability to some products in the series.

Condition for Reflow

Available for Surface Mount Type.

Temperature profile

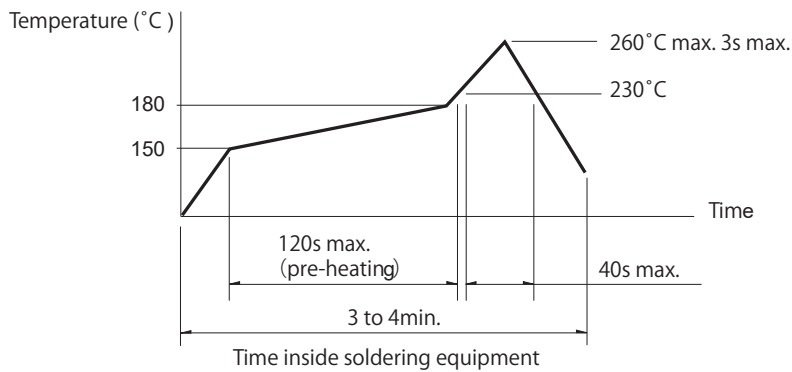

Notes

1. Please confirm the specifications of our product for the detailed condition.
2. Soldering conditions differ depending on reflow soldering machines.
Prior verification of soldering condition is highly recommended.

Conditions for Auto-dip

Available for Snap-in Type and Radial Type.

Items	Condition
Flux built-up	Mounting surface should not be exposed to flux
Preheating temperature	Ambient temperature of the soldered surface of PC board. 100°C max.
Preheating time	60s max.
Soldering temperature	260°C max.
Duration of immersion	5s max.
Number of soldering	2times max.

SKHH Series

Items	Condition
Flux built-up	Mounting surface should not be exposed to flux
Preheating temperature	Ambient temperature of the soldered surface of PC board. 110°C max.
Preheating time	60s max.
Soldering temperature	260°C max.
Duration of immersion	5s max.
Number of soldering	2times max.

SKHL Top Push Type, SKQJ Series

Items	Condition
Flux built-up	Mounting surface should not be exposed to flux
Preheating temperature	Ambient temperature of the soldered surface of PC board. 100°C max.
Preheating time	45s max.
Soldering temperature	255°C max.
Duration of immersion	5s max.
Number of soldering	2times max.

Notes

1. Prevent flux penetration from the top side of the TACT Switch™.
2. Switch terminals and a PC board should not be coated with flux prior to soldering.
3. The second soldering should be done after the switch is stable with normal temperature.
4. Use the flux with a specific gravity of min 0.81.
(EC-19S-8 by TAMURA CORPORATION, or equivalents.)

Manual Soldering

Items	Condition
Soldering temperature	350°C max.
Duration of soldering	3s max.
Capacity of soldering iron	60W max.

SKHH, SKHW Series

Items	Condition
Soldering temperature	360°C max.
Duration of soldering	3s max.
Capacity of soldering iron	60W max.

SKTD, SKTG, SKQJ, SKSN Series

Items	Condition
Soldering temperature	350°C max.
Duration of soldering	3s max.
Capacity of soldering iron	20W max.

DOCUMENT No.	TITLE	PRODUCT SPECIFICATIONS	PAGE												
KRK-701		製品仕様書	1/6												
PRODUCT No.		For reference 参考	Date: 201707												
<p>1. General 一般事項</p> <p>1.1 Application 適用範囲 This specification is applied to TACT switches which have no keytop. この規格書は、キートップなしのタクトスイッチについて適用する。</p> <p>1.2 Operating temperature range 使用温度範囲: <u>-40</u> ~ <u>85</u> °C (normal humidity, normal air pressure 常湿・常圧)</p> <p>1.3 Storage temperature range 保存温度範囲: <u>-40</u> ~ <u>90</u> °C (normal humidity, normal air pressure 常湿・常圧)</p> <p>1.4 Test conditions 試験状態 Unless otherwise specified, the atmospheric conditions for making measurements and tests are as follows. 試験及び測定は特に規定がない限り以下の標準状態のもとで行う。 Normal temperature 常 温: (Temperature 温度 <u>5</u>~<u>35</u>°C) Normal humidity 常 湿: (Relative humidity 湿度 <u>25</u>~<u>85</u>%) Normal air pressure 常 圧: (Air pressure 気圧 <u>86</u>~<u>106</u>kPa) If any doubt arise from judgement, tests shall be conducted at the following conditions. ただし、判定に疑義を生じた場合は以下の基準状態で行う。 Ambient temperature 温 度: <u>20</u>±<u>2</u>°C Relative humidity 相対湿度: <u>60</u>~<u>70</u>% Air pressure 気 圧: <u>86</u>~<u>106</u>kPa</p> <p>2. Appearance, style and dimensions 外観、形状、寸法</p> <p>2.1 Appearance 外観 There shall be no defects that affect the serviceability of the product. 性能上有害な欠陥があってはならない。</p> <p>2.2 Style and dimensions 形状、寸法 Refer to the assembly drawings. 製品図による。</p> <p>3. Type of actuating 動作形式 <u>Tactile feedback</u> <u>タクティールフィードバック</u></p> <p>4. Contact arrangement 回路形式 <u>1</u> poles <u>1</u> throws <u>1</u> 回路 <u>1</u> 接点 (Details of contact arrangement are given in the assembly drawings 回路の詳細は製品図による)</p> <p>5. Ratings 定格</p> <p>5.1 Maximum ratings 最大定格 <u>12</u> V DC <u>50m</u> A</p> <p>5.2 Minimum ratings 最小定格 <u>1</u> V DC <u>10</u> μA</p> <p>6. Electrical specification 電気的性能</p> <table border="1"> <thead> <tr> <th>Items 項目</th> <th>Test conditions 試験条件</th> <th>Criteria 判定基準</th> </tr> </thead> <tbody> <tr> <td>6.1 Contact resistance 接触抵抗</td> <td>Applying a below static load to the center of the stem, measurements shall be made. スイッチ操作部中央に下記の静荷重を加え、測定する。 (1) Depression 押圧力: <u>3.14</u> N (2) Measuring method 測定方法: 1 kHz small-current contact resistance meter or voltage drop method at 5VDC 10mA. 1kHz 微小電流接触抵抗計, 又は DC5V 10mA 電圧降下法</td> <td><u>100m</u> Ω Max.</td> </tr> <tr> <td>6.2 Insulation resistance 絶縁抵抗</td> <td>Measurements shall be made following the test set forth below: 下記条件で試験を行った後、測定する。 (1) Test voltage 印加電圧: <u>100</u> V DC for 1 min. (2) Applied position 印加場所: Between all terminals. And if there is a metal frame, between terminals and ground(frame) 端子間, 金属フレームがある場合は, 端子と金属フレーム間</td> <td><u>100M</u> Ω Min.</td> </tr> <tr> <td>6.3 Voltage proof 耐電圧</td> <td>Measurements shall be made following the test set forth below: 下記条件で試験を行った後、測定する。 (1) Test voltage 印加電圧: <u>250</u> V AC (50~60Hz) (2) Duration 印加時間: 1 min (3) Applied position 印加場所: Between all terminals. And if there is a metal frame, between terminals and ground(frame) 端子間, 金属フレームがある場合は, 端子と金属フレーム間</td> <td>There shall be no breakdown. 絶縁破壊のないこと。</td> </tr> </tbody> </table>				Items 項目	Test conditions 試験条件	Criteria 判定基準	6.1 Contact resistance 接触抵抗	Applying a below static load to the center of the stem, measurements shall be made. スイッチ操作部中央に下記の静荷重を加え、測定する。 (1) Depression 押圧力: <u>3.14</u> N (2) Measuring method 測定方法: 1 kHz small-current contact resistance meter or voltage drop method at 5VDC 10mA. 1kHz 微小電流接触抵抗計, 又は DC5V 10mA 電圧降下法	<u>100m</u> Ω Max.	6.2 Insulation resistance 絶縁抵抗	Measurements shall be made following the test set forth below: 下記条件で試験を行った後、測定する。 (1) Test voltage 印加電圧: <u>100</u> V DC for 1 min. (2) Applied position 印加場所: Between all terminals. And if there is a metal frame, between terminals and ground(frame) 端子間, 金属フレームがある場合は, 端子と金属フレーム間	<u>100M</u> Ω Min.	6.3 Voltage proof 耐電圧	Measurements shall be made following the test set forth below: 下記条件で試験を行った後、測定する。 (1) Test voltage 印加電圧: <u>250</u> V AC (50~60Hz) (2) Duration 印加時間: 1 min (3) Applied position 印加場所: Between all terminals. And if there is a metal frame, between terminals and ground(frame) 端子間, 金属フレームがある場合は, 端子と金属フレーム間	There shall be no breakdown. 絶縁破壊のないこと。
Items 項目	Test conditions 試験条件	Criteria 判定基準													
6.1 Contact resistance 接触抵抗	Applying a below static load to the center of the stem, measurements shall be made. スイッチ操作部中央に下記の静荷重を加え、測定する。 (1) Depression 押圧力: <u>3.14</u> N (2) Measuring method 測定方法: 1 kHz small-current contact resistance meter or voltage drop method at 5VDC 10mA. 1kHz 微小電流接触抵抗計, 又は DC5V 10mA 電圧降下法	<u>100m</u> Ω Max.													
6.2 Insulation resistance 絶縁抵抗	Measurements shall be made following the test set forth below: 下記条件で試験を行った後、測定する。 (1) Test voltage 印加電圧: <u>100</u> V DC for 1 min. (2) Applied position 印加場所: Between all terminals. And if there is a metal frame, between terminals and ground(frame) 端子間, 金属フレームがある場合は, 端子と金属フレーム間	<u>100M</u> Ω Min.													
6.3 Voltage proof 耐電圧	Measurements shall be made following the test set forth below: 下記条件で試験を行った後、測定する。 (1) Test voltage 印加電圧: <u>250</u> V AC (50~60Hz) (2) Duration 印加時間: 1 min (3) Applied position 印加場所: Between all terminals. And if there is a metal frame, between terminals and ground(frame) 端子間, 金属フレームがある場合は, 端子と金属フレーム間	There shall be no breakdown. 絶縁破壊のないこと。													

DOCUMENT No. KRK-701		TITLE PRODUCT SPECIFICATIONS 製品仕様書		PAGE 2/6
PRODUCT No. SKRKAEE020		For reference 参考		Date: 201707
Items 項目	Test conditions 試験条件	Criteria 判定基準		
6.4 Bounce バウンス	<p>Lightly striking the center of the stem at a rate encountered in normal use (3 to 4 operations per s), bounce shall be tested at "ON" and "OFF". スイッチ操作部の中央部を通常の使用状態(3~4回/秒)で軽く打鍵し、ON時及びOFF時のバウンスを測定する。</p>	<p>ON bounce: <u>10</u> ms Max. OFF bounce: <u>10</u> ms Max.</p>		
7. Mechanical specification 機械的性能				
Items 項目	Test conditions 試験条件	Criteria 判定基準		
7.1 Operating force 作動力	<p>Placing the switch such that the direction of switch operation is vertical and then gradually increasing the load applied to the center of the stem, the maximum load required for the switch to come to a stop shall be measured. スイッチの操作方向が垂直になる様にスイッチを設置し、操作部中央部に徐々に荷重を加え、操作部が停止するまでの最大荷重を測定する。</p>	<u>1.57 ± 0.49</u> N		
7.2 Travel 移動量	<p>Placing the switch such that the direction of switch operation is vertical and then applying a below static load to the center of the stem, the travel distance for the switch to come to a make "ON" shall be measured. スイッチの操作方向が垂直になる様にスイッチを設置し、操作部中央部に以下の静荷重を加え、スイッチがONするまでの距離を測定する。 (1) Depression 押圧力: <u>3.14</u> N</p>	<u>0.13</u> <u>+0.07/-0.03</u> mm		
7.3 Return force 復帰力	<p>The sample switch is installed such that the direction of switch operation is vertical and, upon depression of the stem in its center the travel distance, the force of the stem to return to its free position shall be measured. スイッチの操作方向が垂直になる様にスイッチを設置し、操作部中央部を移動量押圧後、操作部が復帰する力を測定する。</p>	<u>0.29</u> N Min.		
7.4 Stop strength ストッパー強度	<p>Placing the switch such that the direction of switch operation is vertical and then a below static load shall be applied in the direction of stem operation. スイッチの操作方向が垂直になる様にスイッチを設置し、スイッチの操作方向へ以下の静荷重を加える。 (1) Depression 押圧力: <u>29.4</u> N (2) Time 時間: <u>15</u> s</p>	There shall be no sign of damage Mechanically and electrically. 機械的、電氣的に異常のないこと。		
7.5 Stem strength ステム抜去強度	<p>Placing the switch such that the direction of switch operation is vertical and then the maximum force to withstand a pull applied opposite to the direction of stem operation shall be measured. スイッチの操作方向が垂直になる様にスイッチを設置し、操作部の操作方向とは反対方向に操作部を引っ張って抜けない力である。</p>	<u>4.9</u> N		
8. Environmental specification 耐候性能				
Items 項目	Test conditions 試験条件	Criteria 判定基準		
8.1 Resistance to low temperatures 耐寒性	<p>Following the test set forth below the sample shall be left in normal temperature and humidity conditions for 1 h before measurements are made: 次の試験後、常温、常湿中に1時間放置後測定する。 (1) Temperature 温度: <u>-40 ± 2</u> °C (2) Time 時間: <u>96</u> h (3) Waterdrops shall be removed. 水滴は取り除く。</p>	Item 6. Item 7.1 Item 7.2		
8.2 Heat resistance 耐熱性	<p>Following the test set forth below the sample shall be left in normal temperature and humidity conditions for 1 h before measurements are made: 次の試験後、常温、常湿中に1時間放置後測定する。 (1) Temperature 温度: <u>90 ± 2</u> °C (2) Time 時間: <u>96</u> h</p>	Item 6. Item 7.1 Item 7.2		
8.3 Moisture resistance 耐湿性	<p>Following the test set forth below the sample shall be left in normal temperature and humidity conditions for 1 h before measurements are made: 次の試験後、常温、常湿中に1時間放置後測定する。 (1) Temperature 温度: <u>60 ± 2</u> °C (2) Time 時間: <u>96</u> h (3) Relative humidity 相对湿度: <u>90 ~ 95</u> % (4) Waterdrops shall be removed. 水滴は取り除く。</p>	Contact resistance 接触抵抗(Item 6.1): <u>200</u> mΩ Max. Insulation resistance 絶縁抵抗(Item 6.2): <u>10</u> MΩ Min. Item 6.3 Item 6.4 Item 7.1 Item 7.2		

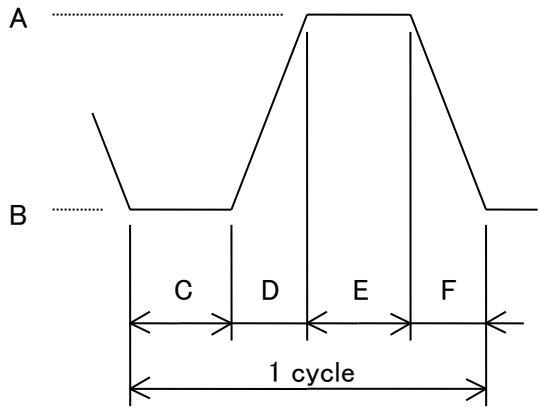
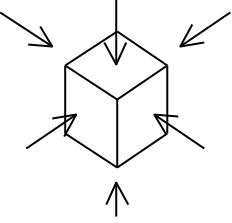
DOCUMENT No. KRK-701		TITLE PRODUCT SPECIFICATIONS 製品仕様書		PAGE 3/6
PRODUCT No. SKRKAEE020		For reference 参考		Date: 201707
Items 項目	Test conditions 試験条件	Criteria 判定基準		
8.4 Change of temperature 温度サイクル	<p>After below cycles of following conditions, the switch shall be allowed to stand under normal room temperature and humidity conditions for 1 h, and measurement shall be made. Water drops shall be removed. 下記条件で以下回数のサイクル試験後、常温常湿中に1時間放置し測定する。ただし、水滴は取り除く。</p>  <p>A = <u>+90</u> °C B = <u>-40</u> °C C = <u>2</u> h D = <u>1</u> h E = <u>2</u> h F = <u>1</u> h</p> <p>(1) Number of cycles サイクル数 : <u>5</u> cycles</p>	Item 6. Item 7.1 Item 7.2		
9. Endurance specification 耐久性能				
Items 項目	Test conditions 試験条件	Criteria 判定基準		
9.1 Operating life 動作寿命	<p>Measurements shall be made following the test set forth below: 下記条件で試験を行った後、測定する。</p> <p>(1) <u>5</u> VDC <u>5</u> mA resistive load 抵抗負荷 (2) Rate of operation 動作速度 : <u>2</u> to <u>3</u> operations per s 回/秒 (3) Depression 押圧力 : <u>2.06</u> Max. (4) Cycles of operation 動作回数 : <u>200,000</u> cycles 回</p>	Contact resistance 接触抵抗(Item 6.1) : <u>200</u> mΩ Max. Insulation resistance 絶縁抵抗(Item 6.2) : <u>10</u> MΩ Min. Bounce パウンス(Item 6.4) : ON bounce : <u>20</u> ms Max. OFF bounce : <u>20</u> ms Max. Operating force 作動力(Item 7.1) : <u>-30</u> ~ <u>+30</u> % of initial force 初期値に対して Item 6.3 Item 7.2		
9.2 Vibration resistance 耐振性	<p>Measurements shall be made following the test set forth below: 下記条件で試験を行った後、測定する。</p> <p>(1) Vibration frequency range 振動数範囲 : <u>10</u> ~ <u>55</u> Hz (2) Total amplitude 全振幅 : <u>1.5</u> mm (3) Sweep ratio 掃引の割合 : <u>10-55-10</u> Hz Approx. <u>1</u> min 約<u>1</u>分 (4) Method of changing the sweep vibration frequency: Logarithmic or uniform 掃引振動数の変化方法 対数又は一様掃引 (5) Direction of vibration: Three mutually perpendicular directions, including the direction of the travel 振動の方向 スイッチ操作方向を中心とした垂直3方向 (6) Duration 振動時間 : <u>2</u> h each (<u>6</u> h in total) 各 <u>2</u> 時間 (計 <u>6</u> 時間)</p>	Item 6.1 Item 7.1 Item 7.2		
9.3 Shock 耐衝撃性	<p>Measurements shall be made following the test set forth below: 下記条件で試験を行った後、測定する。</p> <p>(1) Acceleration 加速度 : <u>784</u> m/s² { <u>80</u> G} (2) Acting time 作用時間 : <u>11</u> msec (3) Test direction 試験方向 : 6 directions 6面 (4) Number of shocks 試験回数 : <u>3</u> times per direction (<u>18</u> times in total) 各方向各 <u>3</u> 回 (計 <u>18</u> 回)</p> 	Item 6.1 Item 7.1 Item 7.2		

DOCUMENT No. KRK-701	TITLE PRODUCT SPECIFICATIONS 製品仕様書	PAGE 4/6
PRODUCT No. SKRKAEE020	For reference 参考	Date: 201707
10. Soldering conditions 半田付条件		
	Items 項目	Recommended conditions 推奨条件
10.1	Hand soldering 手半田	<p>Please practice according to below conditions. 以下の条件にて実施して下さい。</p> <p>(1) Soldering temperature 半田温度 : <u>350</u> °C Max. (2) Continuous soldering time 連続半田時間 : <u>3</u> s Max. (3) Capacity of soldering iron 半田コテ容量 : <u>60</u> W Max. (4) Excessive pressure shall not be applied to the terminal. 端子に異常加圧のないこと</p>
10.2	Reflow soldering リフロー半田	<p>Please practice according to below conditions. 以下の条件にて実施して下さい。</p> <p>(1) Profile 温度プロファイル</p> <p>Surface of product Temperature 部品表面温度(°C)</p> <p>Time inside soldering equipment 炉内通過時間</p> <p>260 °C Max. 3 s Max. Peak Temperature ピーク温度</p> <p>120s Max (Pre-heating 予熱)</p> <p>40 s Max.</p> <p>3 ~ 4 min. Max.</p> <p>(2) Allowable soldering time 半田回数 : <u>2</u> time Max. (The temperature shall go down to a normal temperature in prior to exposure to the second time : 2回目を行う場合には、スイッチが常温に戻ってから行うこと。)</p>
10.3	Other precautions For soldering (Hand soldering) 半田付けに関する その他注意事項 (手半田用)	<p>(1) Following the soldering process, do not try to clean the switch with a solvent or the like. 半田付け後、溶剤などでスイッチを洗浄しないで下さい。</p> <p>(2) Safeguard the switch assembly against flux penetration from its top side. スイッチの上面からフラックスが浸入しないようにして下さい。</p> <p>(3) Hand soldering is suggested for this product to preclude flux penetration into electrical contacts, for dip soldering could pose this problem. 半田付けは手半田にてお願い致します。(オートディップ半田の場合、当製品はフラックスが接点内に浸入することがあります)</p>
10.4	Other precautions For soldering (Reflow soldering) 半田付けに関する その他注意事項 (リフロー用)	<p>(1) Switch terminals and PCB. Upper face shall be free from flux prior to soldering. 事前にスイッチの端子及びプリント基板の部品実装面上にフラックスが塗られていないこと。</p> <p>(2) Following the soldering process, do not try to clean the switch with a solvent or the like. 半田付け後、溶剤などでスイッチを洗浄しないで下さい。</p> <p>(3) Recommended cream solder : M705-GRN360-K2 (SENJU METAL INDUSTRY CO.,LTD) or equivalent 推奨クリーム半田 : 千住金属工業(株) M705-GRN360-K2 同等品</p> <p>(4) When chip components is soldered on the back side of PCB by automatic flow soldering, after this switch soldered by reflow soldering, flux will possibly creep up at the exterior wall of the housing and penetrate into the housing due to flux ejection. Therefore, when the PCB is designed, please do not locate through holes adjacent to the switch mounted area. 本スイッチをリフロー半田後、プリント基板裏面をディップ半田して使用する場合は、ディップ時のフラックス吹き上げ等によりスイッチ側面からフラックスがはい上がる場合がありますので、パターン設計にあたってはスイッチ下面、周囲にスルーホールを設けないで下さい。</p> <p>(5) As the conditions vary somehow depending on the kind of reflow soldering equipment, please make sure you have the right one before use. リフロー槽の種類により、多少条件が異なりますので、事前に十分確認の上使用してください。</p> <p>(6) As the click rate may deteriorate when heat is applied repeatedly, reflow soldering should be performed in the shortest period and at the lowest temperature possible. 熱履歴が加わるとクリック感が低下する可能性がありますので極力低温短時間でリフローを行うようにお願いします。</p> <p>(7) Safeguard the switch assembly against flux penetration from its top side. スイッチの上面からフラックスが浸入しないようにして下さい。</p> <p>(8) The thickness of cream solder : <u>0.15</u> mm クリーム半田印刷厚 : <u>0.15</u> mm</p>

DOCUMENT No. KRK-701	TITLE PRODUCT SPECIFICATIONS 製品仕様書	PAGE 5/6
PRODUCT No. SKRKAEE020	For reference 参考	Date: 201707

【Precaution in use】ご使用上の注意

A. General 一般項目

A1. This switch has been designed and manufactured for general electronic devices, such as audio devices, visual devices, home electronics, inform devices and communication devices. In case this product is used for more sophisticated equipment requiring higher safety and reliability, such as life support system, space & aviation devices, disaster prevention & security system, please make verification of suitability or check on us for the details.
本スイッチはオーディオ機器、映像機器、家電機器、情報機器、通信機器などの一般電子機器用に設計・製造したものです。生命維持装置、宇宙・航空機器、防災・防犯機器などの高度な安全性や信頼性が求められる用途に使用される場合は、貴社にて適合性の確認を頂くか、当社へご確認ください。

A2. This product is designed and manufactured assuming that it is to be used with the resistance for direct current. If you use other kinds of resistance (inductive (L) or capacitive (C)), please let us know beforehand.
本製品は直流の抵抗負荷を想定して設計・製造されています。その他の負荷(誘導性負荷(L)、容量性負荷(C))で使用される場合は、別途ご相談ください。

B. Soldering and assemble to PC board process 半田付, 基板実装工程

B1. Note that if the load is applied to the terminals during soldering they might suffer deformation and defects in electrical performance.
端子をはんだ付けされる場合、端子に荷重が加わりますと条件によりガタ、変形及び電気的特性劣化のおそれがありますのでご注意ください。

B2. If the stem is given stress from the side, it may result in damages to switch functions. Therefore please handle it with extreme care.
When the switch is carried, any shock shall not be applied to the stem.
ステムに横からの力が加わりますと、スイッチの機能破壊につながる危険性がありますので取扱いは十分注意して下さい。
移動する場合はステムに衝撃が加わらない様に注意して下さい。

B3. As this TACT switch is designed for reflow soldering, if you place it at the edge of PCB for convenience, then flux may get into the sliding part of the SW during automatic dip soldering after being mounted, so do not apply auto dip after being mounted.
当タクトスイッチはリフロー半田対応ですが、スイッチ実装後にオートディップを行う場合にスイッチが基板の端にあるとフラックスが浸入する恐れがありますので十分にご注意下さい。

B4. As the click rate may deteriorate when heat is applied repeatedly, reflow soldering should be done within the recommended conditions.
熱履歴が加わるとクリック感が低下する可能性がありますので推奨リフロー条件以内でリフローを行う様にお願いします。

C. Washing process 洗浄工程

C1. Following the soldering process, do not try to clean the switch with a solvent or the like.
半田付け後、溶剤等でスイッチを洗浄しないでください。

D. Mechanism design (switch layout) 機構設計

D1. The dimensions of a hole and pattern for mounting a printed circuit board shall refer to the recommended dimensions in the engineering drawings.
プリント基板取付穴及びパターンは、製品図に記載されている推奨寸法をご参照下さい。

D2. You may dip-solder chip components on the backside of PCB after you have reflow-soldered this switch. However, dip-soldering may cause flux to creep up on the wall of the housing and penetrate the switch. Therefore, do not design a through hole under and around the switch.
本スイッチをリフロー半田後、プリント基板裏面をディップ半田して使用する場合は、ディップ時のフラックス吹き上げ等により、スイッチ側面より、フラックスがはい上がる場合がありますので、パターン設計にあたっては、スイッチ下面、周囲にスルーホールを設けないで下さい。

D3. Do not use the switch in a manner that the stem will be given stress from the side. If you push the stem from the side, the switch may be broken.
ステムを横方向から押す様な使い方は避けて下さい。ステム先端に横方向から荷重が加わりますとスイッチが破壊される場合があります。

D4. Press the center of the stem. Click feel may be changed, if you press the edge. This is because the center will be displaced, depending on the hinge structure or cumulative tolerances. When you use the hinge structure, take special care so that the keytop point to press the switch won't move.
ステムのセンターを押す様にして下さい。ヒンジ構造及びセット上の累積公差によるセンターズレなどステムを端押しする状態では感触が変化する場合があります。ヒンジ構造の場合は、押下時ステム押し位置が移動しますので、特にご注意下さい。

D5. This switch is designed for unit construction that it is pressed by human operation. Please avoid using this switch as mechanical detecting function.
In case such detecting function is required, please consult with our detector switch section.
当スイッチは、直接人の操作を介してスイッチを押す構造にてご使用下さい。メカ的な検出機能へのご使用は、避けて下さい。
検出機能には弊社検出スイッチをご使用下さい。

D6. The switch will be broken, if you give larger stress than specified. Take most care not to let the switch be given larger stress than specified.
(Refer to the strength of the stopper.)
スイッチ操作時に規定以上の荷重が加わるとスイッチが破損する場合があります。スイッチに規定荷重以上の力が加わらない様にご注意下さい。
(ストッパー強度参照)

D7. Allowable inclination of keying section: 90±5 degrees or less.
打鍵部中心軸線の傾きは、90±5度以内に設定して下さい。

DOCUMENT No. KRK-701	TITLE PRODUCT SPECIFICATIONS 製品仕様書	PAGE 6/6
PRODUCT No. SKRKAEE020	For reference 参考	Date: 201707

E. Using environment 使用環境

E1. If you use this product in one of the following environmental conditions, progress of sulfuratio and oxidization on the contact part will be accelerated, which may cause contact failure. Therefore, be careful about the supp.

以下の様な環境下で使用されますと、当製品の性能に影響を及ぼすおそれがありますので使用環境に十分にご注意下さい。

(1) Around a sulfurate hot spring where sulfide gas is generated. And in case this product is always used in a place where exhaust gas from automobiles exist.
硫黄系温泉地等常時ガスが発生する場所や自動車等の排気ガスの発生する場所で常時使用する場合

(2) Follow the directions if you have parts/materials described below within the module where the switch is installed.

同一セット内に以下の様な部材に関しましては以下の点にご注意願います。

•For parts, rubber materials, adhesive agents, plywood, packing materials and lubricant used for the mechanical part of the device, do not use those ones that may generate gas of sulfurization or oxidization.

部品、ゴム材料、接着剤、合板、機器の梱包材、機器内の駆動部に使用される潤滑剤については、硫化、酸化ガスが発生しないものを採用してください。

•When you use silicon rubber, grease, adhesive agents and oil, use those that will not generate low molecular siloxane gas. The low molecular siloxane gas may form silicon dioxide coat on the SW contact part, resulting in the contact failure.

シリコン系ゴム、グリース、接着剤、オイルを使用される場合は、低分子シロキサンガスが発生しないものを使用してください。低分子シロキサンガスが発生しますとSW接点部に2酸化珪素の被膜を形成して接点障害を引き起こす場合があります。

(3) When you apply chemical agents such as coating agents to the products, please let us know beforehand.

製品のコーティング剤等の薬品を付着させる場合は、別途ご相談ください。

E2. Do not use this switch in the atmosphere with high humidity or with bedewing probability, because such atmosphere may cause leak among terminals.

高湿度環境下、又は結露する可能性がある環境では、端子間の電流リークが発生する可能性がありますので本スイッチはご使用にならないでください。

F. Storage method. 保管方法

F1. If you don't use the product immediately, store it as delivered in the following environment: with neither direct sunshine nor corrosive gas and in normal temperatures. However, it is recommended that you should use it as soon as possible before six months pass.

製品は納入形態のまま常温、常湿で直射日光の当たらず腐食性ガスが発生しない場所に保管し納入から6ヶ月以内を限度として出来るだけ早くご使用ください。

F2. After you break the seal, you should put the remaining in a plastic bag to separate it from the outside and store it in the same environment mentioned above. You should use it up as soon as possible.

開封後はポリフクロで外気との遮断を図り上記と同じ環境下で保管しすみやかにご使用下さい。

F3. Do not stack too many switches for strafe.

過剰な積み重ねは行わないで下さい。

G. Others. その他

G1. This specification will be invalid one year after it is issued, if you don't return it or don't place an order.

本仕様書は発行日より1年間を経過して、ご返却又はご発注の無い場合は、無効とさせていただきます。

G2. Please understand that the specifications other than electric and mechanical characteristics and outside dimensions may be changed at our own discretion.

電氣的、機械的特性、外観寸法および取付寸法以外につきましては、当社の都合により変更させて頂く事が有りますので、あらかじめ御了承下さい。

G3. Never use the product beyond the rating. It may catch fire. If you think that the product may be used beyond the rating due to some abnormal conditions, you must take certain protective measures, such as a protective circuit to shut down the current.

定格を超えての使用は火災発生のおそれがありますので絶対に避けて下さい。また異常使用等で定格を超える恐れがある場合は保護回路等で電流遮断等の対策をして下さい。

G4. The flammability grade of the plastic used for this product is "94HB" by the UL Standard (slow burning). Therefore, either refrain from using it in the place where it can catch fire, or take measures to preclude catching fire.

本製品に使用している樹脂等の燃焼グレードはUL規格の"94HB"(遅燃性グレード)相当を使用しております。つきましては類焼の恐れがある場所での使用を禁止するか、類焼防止対策をお願いします。

G5. Though we are confident in switch quality, we cannot deny the possibility that they could fail due to short or open circuit. Therefore, if you use a switch for a product requiring higher safety level, we would like you to verify in advance what effects your module would receive in case the switch alone should fail. And secure safety as a whole system by introducing the fail-safe design, i.e. a protection network.

スイッチの品質には万全を尽くしていますが故障モードとしてショート、オープンが発生が皆無とは言えません。安全性が重視されるセットの設計に際しては、スイッチの単品故障に対してセットとしての影響を事前にご検討いただき、保護回路、等のフェールセーフ設計のご検討を十分に行い安全を確保して頂きますようお願いいたします。