

Modbus RTU (EIA-485) Interface for Panasonic air conditioners

Compatible with Ethera line air conditioners commercialized by Panasonic

USER MANUAL

Issue date: 11/2024 r1.4 ENGLISH



Modbus RTU (EIA-485) Interface for Panasonic air conditioners

Compatible with Etherea line air conditioners commercialized by Panasonic

ORDER CODE	LEGACY ORDER CODE
INMBSPAN001I100	PA-AC-MBS-1

Important User Information

Disclaimer

The information in this document is for informational purposes only. Please inform HMS Industrial Networks of any inaccuracies or omissions found in this document. HMS Industrial Networks disclaims any responsibility or liability for any errors that may appear in this document.

HMS Industrial Networks reserves the right to modify its products in line with its policy of continuous product development. The information in this document shall therefore not be construed as a commitment on the part of HMS Industrial Networks and is subject to change without notice. HMS Industrial Networks makes no commitment to update or keep current the information in this document.

The data, examples and illustrations found in this document are included for illustrative purposes and are only intended to help improve understanding of the functionality and handling of the product. In view of the wide range of possible applications of the product, and because of the many variables and requirements associated with any particular implementation, HMS Industrial Networks cannot assume responsibility or liability for actual use based on the data, examples or illustrations included in this document nor for any damages incurred during installation of the product. Those responsible for the use of the product must acquire sufficient knowledge in order to ensure that the product is used correctly in their specific application and that the application meets all performance and safety requirements including any applicable laws, regulations, codes and standards. Further, HMS Industrial Networks will under no circumstances assume liability or responsibility for any problems that may arise as a result from the use of undocumented features or functional side effects found outside the documented scope of the product. The effects caused by any direct or indirect use of such aspects of the product are undefined and may include e.g. compatibility issues and stability issues.

INDEX

- 1. Presentation 5
- 2. Connection 6
 - 2.1 Connect to the AC indoor unit 6
 - 2.2 Connection to the EIA-485 bus 6
- 3. Quick Start Guide..... 7
- 4. Modbus Interface Specification 8
 - 4.1 Modbus physical layer..... 8
 - 4.2 Modbus Registers..... 8
 - 4.2.1 Control and status registers 8
 - 4.2.2 Configuration Registers..... 12
 - 4.2.3 Considerations on Temperature Registers 12
 - 4.3 DIP-switch Configuration Interface 15
 - 4.4 Implemented Functions 18
 - 4.5 Device LED indicator 18
 - 4.6 EIA-485 bus. Termination resistors and Fail-Safe Biasing mechanism 18
- 5. Electrical and Mechanical features 19
- 6. List of supported AC Unit Types. 20
- 7. Error Codes 21

1. Presentation



The INMBSPAN001I100 interfaces allow a complete and natural integration of **Panasonic** air conditioners into Modbus RTU (EIA-485) networks.

Compatible with all models of Etherea line. Check the section 6 for more information.

Reduced dimensions. 93 x 53 x 58 mm // 3.7" x 2.1" x 2.3"

- Quick and easy installation.
Mountable on DIN rail, wall, or even inside the indoor unit on some models of AC.
- External power not required.
- Direct connection to Modbus RTU (EIA-485) networks. Up to 63 INMBSPAN001I100 devices can be connected on the same network.
INMBSPAN001I100 is a Modbus slave device.
- Direct connection to the AC indoor unit. Up to 1 AC indoor units can be connected to INMBSPAN001I100. *The cable for this connection is also supplied.*
- Configuration from both on-board DIP-switches and Modbus RTU.
- Total Control and Supervision.
- Real states of the AC unit's internal variables.
- Allows simultaneous use of the AC's remote controls and Modbus RTU.

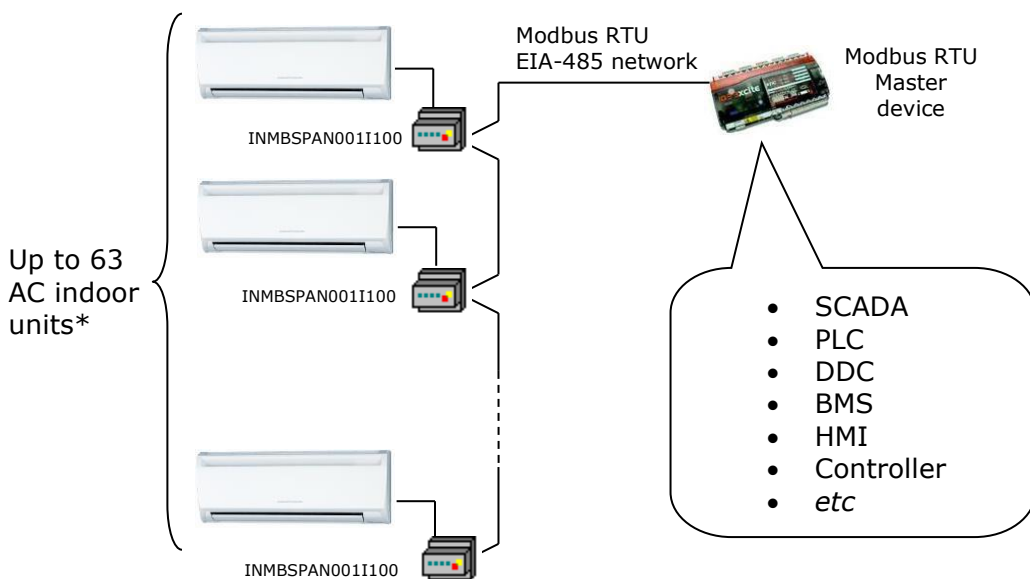

* Up to 63 Intesis devices can be installed in the same Modbus RTU bus. However, depending on the configured speed, the installation of Modbus Repeaters may be required

2. Connection

The interface comes with a specific cable and connectors to establish direct connection with the AC indoor unit. It comes as well with a plug-in terminal block of 2 poles to establish direct connection with the Modbus RTU EIA-485 network.

2.1 Connect to the AC indoor unit

To connect the INMBSPAN001I100 interface with the AC indoor unit you must follow these steps:

Disconnect Mains Power from the AC unit. Open the front cover of the indoor unit to have access to the electronic circuit. Once you arrive at the electronic circuit, locate the socket connector marked as **CN-CNT**.

Take the cable that comes with the interface, insert one of its connectors (the one installed in the shortest uncovered part) into the socket of the INMBSPAN001I100, and the other connector (the one installed in the largest uncovered part) to the socket **CN-CNT** of the AC unit's electronic circuit. You can place the INMBSPAN001I100 inside or outside the AC indoor unit depending on your needs. Remember that the INMBSPAN001I100 must also be connected to the Modbus RTU EIA-485 network. Close the AC indoor unit's front cover again to finish the connection.

The cable supplied with the interface is 1.5 m (4.9 ft) long. Do not modify its length since it may affect the correct interface's operation. Keep the cable away from power and ground wires, and never bundle them together.

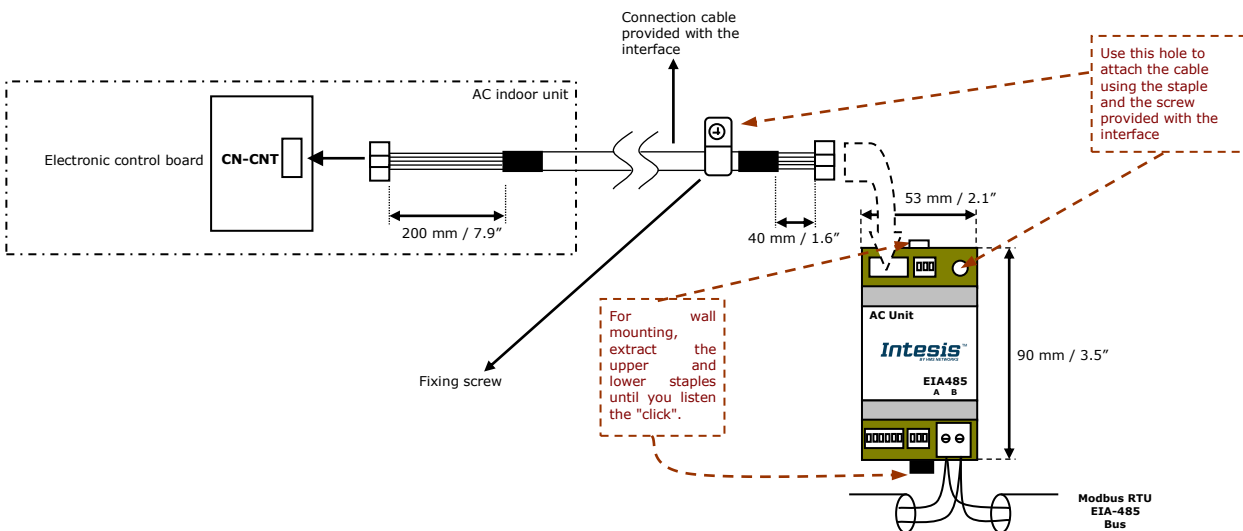

2.2 Connection to the EIA-485 bus

Connect the EIA-485 bus wires to the plug-in terminal block (the one of two poles) of INMBSPAN001I100 and keep the polarity on this connection (A+ and B-). Make sure that the maximum distance to the bus is 1,200 meters (3,937 ft). Loop or star typologies are not allowed in the case of the EIA-485 bus. A terminator resistor of 120Ω must be present at each end of

the bus to avoid signal reflections. The bus needs a fail-safe biasing mechanism (see section 4.6 for more details).

3. Quick Start Guide

1. Disconnect the air conditioning from the Mains Power.
2. Attach the interface next to the AC indoor unit (wall mounting) following the instructions of the diagram below or install it inside the AC indoor unit (respect the safety instructions given).
3. Connect the connection cable included with the interface between the interface and the AC indoor unit following the instructions of the diagram.
4. Connect the EIA-485 bus to the connector *EIA485* of the interface.
5. Close the AC indoor unit.
6. Check the DIP-Switch configuration of the Intesis interface and make sure it matches the current installation's parameters (see section 4.3).

By default, the interface is set to:

- Modbus Slave Address → 1
- Modbus baud rate → 9600 bps



These parameters can be modified from SW4 and SW3 DIP-Switches.

All other switch positions are set at low level (Off position) by default.

NOTE: All changes on the DIP-Switch configuration require a system power cycle to be applied.

7. Connect the AC system to Mains Power.

IMPORTANT: The Intesis interface requires to be connected to the AC unit (powered) to start communicating.

4. Modbus Interface Specification

4.1 Modbus physical layer

INMBSPAN001I100 implements a Modbus RTU (Slave) interface, to be connected to an EIA-485 line. It performs 8N2 communication (8 data bits, no parity and 2 stop bit) with several available baud rates (2400 bps, 4800 bps, 9600 bps, 19200 bps, 38400 bps, 57600 bps, 76800 bps and 115200 bps). It also supports 8N1 communication (8 data bits, no parity and 1 stop bit).

NOTE: The gateway automatically detects the communication type (8N2 or 8N1) and sets itself accordingly. No action is needed.

4.2 Modbus Registers

All registers are type "16-bit unsigned Holding Register" and they use the standard *Modbus big endian* notation.

4.2.1 Control and status registers

Register Address (protocol address)	Register Address (PLC address)	R/W	Description
0	1	R/W	AC unit On/Off <ul style="list-style-type: none"> ▪ 0: Off ▪ 1: On
1	2	R/W	AC unit Mode ¹ <ul style="list-style-type: none"> ▪ 0: Auto ▪ 1: Heat ▪ 2: Dry ▪ 3: Fan ▪ 4: Cool
2	3	R/W	AC unit Fan Speed ¹ <ul style="list-style-type: none"> ▪ 0: Auto ▪ 1: Low ▪ 2: Mid-1 ▪ 3: Mid-2 ▪ 4: Mid-3 ▪ 5: High
3	4	R/W	AC unit Vertical Vane Position ¹ <ul style="list-style-type: none"> ▪ 0: Auto ▪ 1: Horizontal ▪ 2: Position-2 ▪ 3: Position-3 ▪ 4: Position-4 ▪ 5: Vertical ▪ 6: Swing
4	5	R/W	AC unit Temperature setpoint ^{1,2,3} <ul style="list-style-type: none"> ▪ -32768 (Initialization value) ▪ 16..30°C (°C/x10°C) ▪ 61..88°F

¹ Available values will depend on the AC unit mode. Check the AC unit model functions in its user manual to know the possible values for this register.

² Magnitude for this register can be adjusted to Celsius x 1°C, Celsius x 10°C (default) or Fahrenheit. See section 4.2.3 for more information.

³ It is not possible turn to x10 the value shown in Fahrenheit.

Register Address (protocol address)	Register Address (PLC address)	R/W	Description
5	6	R	AC unit Temperature reference ^{1,2,3,4} <ul style="list-style-type: none"> -32768 (Initialization value) 10..42°C (°C/x10°C) 50..108°F
6	7	R/W	Window Contact <ul style="list-style-type: none"> 0: Closed (Default value) 1: Open
7	8	R/W	INMBSPAN001I100 Disablement ⁵ <ul style="list-style-type: none"> 0: INMBSPAN001I100 enabled (Default) 1: INMBSPAN001I100 disabled
8	9	R/W	AC Remote Control Disablement ⁵ <ul style="list-style-type: none"> 0: Remote control enabled (Default) 1: Remote control disabled
9	10	R/W	AC unit Operation Time ⁵ <ul style="list-style-type: none"> 0..65535 (hours). Counts the time the AC unit is in "On" state.
10	11	R	AC unit Alarm Status <ul style="list-style-type: none"> 0: No alarm condition 1: Alarm condition
11	12	R	Error Code ⁶ <ul style="list-style-type: none"> 0: No error present 65535 (-1 if read as a signed value): Error in the communication of INMBSPAN001I100 with the AC unit. Any other error present, see the table at the end of this document.
22	23	R/W	Indoor unit's ambient temperature from external sensor (at Modbus side) ^{1,2,3,7} <ul style="list-style-type: none"> -32768: (Initialization value). No temperature is being provided from an external sensor. Any other: (°C/x10°C/°F)
23	24	R	AC Real temperature setpoint ^{1,2,3,7} <ul style="list-style-type: none"> When no external temperature is provided, this read-only register will have the same value as register 5 (PLC addressing). In all cases, it will show the current setpoint in the indoor unit. 16..31°C (°C/x10°C) 60..92°F
24	25	R	Current AC max. setpoint ^{1,2,3} <ul style="list-style-type: none"> -32768 (Initialization value) 30°C (°C/x10°C) 86°F
25	26	R	Current AC min. setpoint ^{1,2,3} <ul style="list-style-type: none"> -32768 (Initialization value) 16°C (°C/x10°C) 61°F

⁴ Feature only available on 2013 models (PKE series) and onwards.

⁵ This value is stored in non-volatile memory

⁶ See section 7 for possible error codes and their explanation

⁷ See section 4.2.3 for more information

Register Address (protocol address)	Register Address (PLC address)	R/W	Description
26	27	R/W	AC unit Horizontal Vane Position ¹ <ul style="list-style-type: none"> ▪ 0: Auto ▪ 1: Horizontal ▪ 2: Position-2 ▪ 3: Position-3 ▪ 4: Position-4 ▪ 5: Vertical
37	38	R	Auto mode <ul style="list-style-type: none"> ▪ 0: Auto (Default value) ▪ 1: Heat ▪ 2: Dry ▪ 3: Fan ▪ 4: Cool
38	39	R/W	Powerful <ul style="list-style-type: none"> ▪ 0: Off (Default value) ▪ 1: On
39	40	R/W	Quiet <ul style="list-style-type: none"> ▪ 0: Off (Default value) ▪ 1: On
53	54	R	Compressor Status <ul style="list-style-type: none"> ▪ 0: Off (Default value) ▪ 1: To off ▪ 2: To on ▪ 3: On
54	55	R/W	Compressor On Time ⁵ <ul style="list-style-type: none"> ▪ 0..65535 (hours)
55	56	R/W	Under voltage Count <ul style="list-style-type: none"> ▪ 0..300
56	57	R/W	Heat 8/10 °C Mode ^{1,8} <ul style="list-style-type: none"> ▪ 0: Off (Default value) ▪ 1: On
57	58	R/W	ECO Mode ⁴ <ul style="list-style-type: none"> ▪ 0: Off (Default value) ▪ 1: ECONAVI ▪ Auto Comfort
58	59	R	Demand Response (DRM level) ⁴ <ul style="list-style-type: none"> ▪ 0: Normal (Default value) ▪ 1: Comp OFF (DRM1) ▪ 2: 50% (DRM2) ▪ 3: 75% (DRM3)
59	60	R	Human Activity ⁴ <ul style="list-style-type: none"> ▪ 0: Exist (Default value) ▪ 1: Not Exist
60	61	R	Outdoor intake temperature ^{1,2,3,4} <ul style="list-style-type: none"> ▪ -32768: (initialization value) No temperature's value is being provided from an external sensor. ▪ Any other: (°C/x10°C/°F)
61	62	R	Power Consumption ^{4,9} <ul style="list-style-type: none"> ▪ Value expressed in W
62	63	R	Operation Current ^{4,9} <ul style="list-style-type: none"> ▪ Value expressed in mA

⁸ When the value is 1 means that the value goes between 5°C and 8°C.

⁹ The reading of this register equals to the consumption of the full AC system, not the consumption from one single unit.

Register Address (protocol address)	Register Address (PLC address)	R/W	Description
63	64	R	Power Consumption (Slow) ^{4,9} <ul style="list-style-type: none"> Value expressed in W. The frequency of the updates is lower than the one of register 61 (62 PLC)
65	66	R	Input reference temperature ⁴ <ul style="list-style-type: none"> -32768: (initialization value) No temperature's value is being provided from an external sensor. Any other: (°C/x10°C/°F)
66	67	R	Return path temperature ^{1,2,3} <ul style="list-style-type: none"> Temperature on the air return of the AC unit (°C/x10°C/°F).
72	73	R	Today Energy – MSW ^{4,10} <ul style="list-style-type: none"> 0..65535 (hours). Value expressed in Watt-hour (Energy consumption throughout the day).
73	74	R	Today Energy – lsw ^{4,10} <ul style="list-style-type: none"> 0..65535 (hours). Value expressed in Watt-hour (Energy consumption throughout the day).
74	75	R	Yesterday Energy – MSW ^{4,10} <ul style="list-style-type: none"> 0..65535 (hours). Value expressed in Watt-hour (Energy consumption throughout the previous day).
75	76	R	Yesterday Energy – lsw ^{4,10} <ul style="list-style-type: none"> 0..65535 (hours). Value expressed in Watt-hour (Energy consumption throughout the previous day).
76	77	R/W	Total Energy – MSW ^{4,10} <ul style="list-style-type: none"> 0..65535 (hours). Value expressed in Watt-hour
77	78	R/W	Total Energy – lsw ^{4,10} <ul style="list-style-type: none"> 0..65535 (hours). Value expressed in Watt-hour
97	98	R/W	Block Periodic Sendings ^{11,12} <ul style="list-style-type: none"> 0: Non-blocked (Default value) 1: Blocked

¹⁰ MSW is related to the concept *Most Significant word* and lsw is related to the concept *Least Significant word*.

¹¹ If the register is configured as "0:Non-blocked", all commands received from Modbus will be sent to the AC system. If "1: Blocked", all commands received from Modbus will be sent to the AC system if they differ from the previous value.

¹² This register applies to firmware version 2.3 onwards

4.2.2 Configuration Registers

Register Address (protocol address)	Register Address (PLC address)	R/W	Description
13	14	R/W	"Open Window" switch-off timeout ¹³ <ul style="list-style-type: none"> 0..30 (minutes) Factory setting: 30 (minutes)
14	15	R	Modbus RTU baud-rate <ul style="list-style-type: none"> 2400bps 4800bps 9600bps (Default) 19200bps 38400bps 57600bps 76800bps 115200bps
15	16	R	Device's Modbus Slave address <ul style="list-style-type: none"> 1..63
21	22	R	Max. number of fan speeds
49	50	R	Device ID: 0x0C00
50	51	R	Software version
78	79	R/W	Today: Year ⁴ <ul style="list-style-type: none"> 2000: Default value Value expressed without units (It shows the year configured).
79	80	R/W	Today: Month ⁴ <ul style="list-style-type: none"> 1: Default value Value expressed without units (It shows the month configured).
80	81	R/W	Today: Day ⁴ <ul style="list-style-type: none"> 0: Default value Value expressed without units (It shows the day configured).

4.2.3 Considerations on Temperature Registers

- AC unit temperature setpoint (R/W)**
 (register 4 – in Protocol address / register 5 – in PLC address):
 This is the adjustable temperature setpoint value that must be required by the user. This register can be read (Modbus function 3 or 4) or written (Modbus functions 6 or 16). A remote controller connected to the Panasonic indoor unit will report the same temperature setpoint value as this register, but only will happen when no AC unit's external reference is provided from INMBSPAN001I100 (see detail for register 22/23 below).
- AC unit temperature reference (R)**
 (register 5 – in Protocol address / register 6 – in PLC address):
 This register reports the temperature that is currently used by the Panasonic indoor unit as the reference of its own control loop. Depending on the configuration of the indoor unit, this value can be the temperature reported by the sensor on the return path of the Panasonic indoor unit or the sensor of its remote controller. It is a read-only register (Modbus functions 3 or 4).

¹³ Once window contact is open, a count-down to switch off the AC Unit will start from this configured value.

- **AC unit external temperature reference (Modbus) (R/W)**

(register 22 – in Protocol address / register 23 – in PLC address):

This register allows us to provide an external temperature reference from the Modbus side. Panasonic indoor unit does not allow on devices like INMBSPAN001I100 to provide directly temperature to be used as a reference of the control loop of the AC indoor unit. In order to overcome this limitation and enable the usage of an external temperature sensor (i.e. in Modbus side), INMBSPAN001I100 applies the following mechanism (only if "external temperature's reference" is being used):

- After a couple of values have been entered in the "AC unit external temperature's reference" (register 22/23) and "AC unit temperature set point" (register 4/5), INMBSPAN001I100 is going to estimate the temperature chosen implied (e.g. if a "temperature setpoint (register 4/5)" of **22°C**, and an "external temperature reference (register 22/23)" of **20°C** are entered, INMBSPAN001I100 will assume that the user is demanding a **+2°C** increase in temperature).
- By knowing at any time the ambient temperature currently used by the indoor unit to control its own operation (register 5/6), INMBSPAN001I100 can calculate the required temperature setpoint needed to apply the decrease/increase on the real temperature and reach the temperature chosen by the user (following the example above, if INMBSPAN001I100 reads an "ambient temperature" (register 5/6) of **24°C** in the indoor unit, it will apply a final setpoint of **24°C + 2°C = 26°C**).
- At this moment, each time that INMBSPAN001I100 detects a change on the ambient temperature reported by the indoor unit (register 5/6), it will also change the required setpoint, in order to keep the temperature required by the user at any time. If we follow the last example, if INMBSPAN001I100 receives a new temperature's value coming from the indoor unit of **25°C**, INMBSPAN001I100 will automatically adjust the temperature setpoint required of the AC indoor unit to **25°C + 2°C = 27°C**).
- In general, INMBSPAN001I100 is constantly applying the "Virtual Temperature" formula:

$$S_{AC} = S_u - (T_u - T_{AC})$$

Where:

- S_{AC} - setpoint value currently applied to the indoor unit
- S_u - setpoint value written at Modbus side (register 4/5)
- T_u - external temperature reference written at Modbus side (register 22/23)
- T_{AC} - ambient temperature that the indoor unit is using as the reference of its own control loop (register 5/6)

When INMBSPAN001I100 detects a change in any of the values of $\{ S_u, T_u, T_{AC} \}$, it will send the new setpoint (S_{AC}) to the indoor unit.

- After the startup, the value for "external temperature's reference" (register 22/23) has a value -32768 (0x8000). This value means that no external temperature reference is being provided through INMBSPAN001I100. In this scenario, the setpoint value shown in register 4/5 will always be the same as the current setpoint value of the indoor unit.
- Notice that, the use of the "external temperature reference" (register 22/23) (e.g., writing a value different from -32768 / 0x8000 in it) has the following relevant consequences:

- The mechanism of "Virtual Temperature" is applied. The temperature setpoint's value shown by the Remote Controller or other Control System from Panasonic connected to the indoor unit may show a different value from the value shown in register 4/5.
 - The User is not be able to change the setpoint using any Remote Controller from Panasonic, as setpoint of the indoor unit becomes exclusively controlled by the "Virtual Temperature" mechanism.
- **AC Real temperature setpoint (R)**
(register 23 – In Protocol address / register 24 – in PLC address):

As it has been detailed on the previous point, the real temperature setpoint in the indoor unit and the temperature setpoint requested from INMBSPAN001I100 might differ (when a value in register 22/23 – "external temperature reference" is entered). This register always informs about the current temperature setpoint which is being used by the indoor unit – it also includes the temperature setpoint that will be shown by an additional remote controller from Panasonic connected to the indoor unit, if it is present on the system.

Moreover, notice that temperature's values of all these four registers are expressed according to the temperature's format configured through its onboard DIP-Switches (See "4.3 - DIP-switch Configuration Interface"). These following formats are possible:

- **Celsius value:** Value in Modbus register is the temperature value in Celsius (i.e. a value "22" in the Modbus register must be interpreted as 22°C).
- **Decicelsius value:** Value in Modbus register is the temperature value in decicelsius (i.e. a value "220" in the Modbus register must be interpreted as 22.0°C).
- **Fahrenheit value:** Value in Modbus register is the temperature value in Fahrenheit (i.e. a value "72" in the Modbus register must be interpreted as 72°F (~22°C)).

4.3 DIP-switch Configuration Interface

All the configuration values on INMBSPAN001I100 can be written and read from Modbus interface. Otherwise, some of them can also be setup from its on-board DIP-switch interface. The device has DIP-switches SW1, SW3 and SW4 on the following locations:

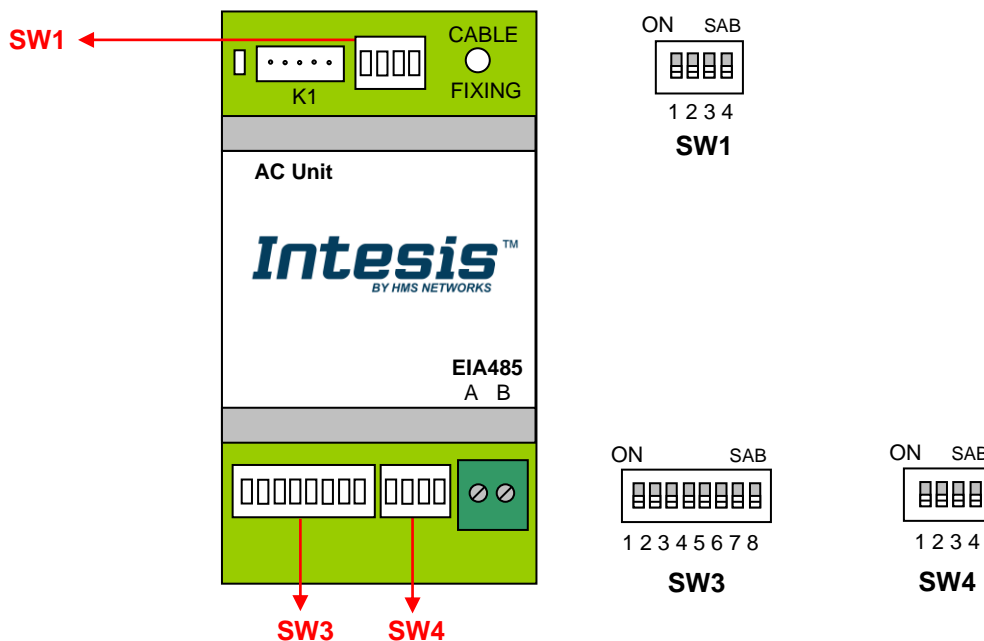

The following tables apply to the interface's configuration through DIP-switches:

SW1 – AC indoor unit's configuration

SW1-P1..4	Description
	AC unit does not have FAN mode (Panasonic AC unit does not have FAN mode available).
	AC unit has FAN mode (Default mode) (Panasonic AC unit has FAN mode available).
	AC unit does not have horizontal vanes.
	AC unit has horizontal vanes (Default value).
	Keep the switch into this position (Default value).
	Do not turn the switch into this position (not applicable).
	Keep the switch into this position (Default value).
	Do not turn the switch into this position (not applicable).

Table 4.1 SW1: AC indoor unit's configuration

SW3/SW4 – Baud rate configuration













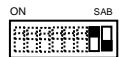



SW3-P7..8	SW4-P3	Description
		2400bps
		4800bps
		9600bps (Default)
		19200bps
		38400bps
		57600bps
		76800bps
		115200bps

Table 4.2 SW3-SW4: Modbus baud rate

SW4 – Degrees/Decidegrees (x10), temperature magnitude (°C/°F) and EIA-485 termination resistor.

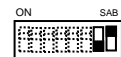

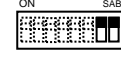



SW4-P1..2-4	Description
	Temperature values in Modbus register are represented in degrees (x1) (Default value)
	Temperature values in Modbus register are represented in decidegrees (x10)
	Temperature values in Modbus register are represented in Celsius degrees (Default value)
	Temperature values in Modbus register are represented in Fahrenheit degrees
	EIA-485 bus without termination resistor (Default value)
	Internal termination resistor of 120Ω connected to EIA-485 bus

Table 4.3 SW4: Temperature and termination resistor configuration

SW3 – Modbus Slave address

Add	SW3-P1..6	Add	SW3-P1..6	Add	SW3-P1..6	Add	SW3-P1..6	Add	SW3-P1..6
0		13		26		39		52	
1		14		27		40		53	
2		15		28		41		54	
3		16		29		42		55	
4		17		30		43		56	
5		18		31		44		57	
6		19		32		45		58	
7		20		33		46		59	
8		21		34		47		60	
9		22		35		48		61	
10		23		36		49		62	
11		24		37		50		63	
12		25		38		51			

Table 4.4 SW3: Modbus slave address

4.4 Implemented Functions

INMBSPAN001I100 implements the following standard Modbus functions:

- 3: Read Holding Registers
- 4: Read Input Registers
- 6: Write Single Register
- 16: Write Multiple Registers (Despite this function is allowed, the interface does not allow to write operations on more than 1 register with the same request, this means that length field should be always be 1 when this function is being used in case of writing)

4.5 Device LED indicator

The device includes a LED indicator to show all the possible operational states. In the following table there are written the indicators which can be performed and its meaning.

Device status	LED indication	ON / OFF Period	Description
On power-up	LED pulse	ON for 5 seconds / OFF after	Device reset / power-up
During normal operation	LED flashing	200ms ON / 2s OFF	Device correctly configured and working
During normal operation	LED OFF	OFF continuously	No Modbus Slave address configured
During normal operation	LED blinking	200ms ON / 200ms OFF	Communication Error with the AC unit

4.6 EIA-485 bus. Termination resistors and Fail-Safe Biasing mechanism

EIA-485 bus requires a 120Ω terminator resistor at each end of the bus to avoid signal reflections.

In order to prevent fail status detected by the receivers, which are "*listening*" the bus, when all the transmitters' outputs are in three-state (high impedance), it is also required a fail-safe biasing mechanism. This mechanism provides a safe status (a correct voltage level) in the bus when all the transmitters' outputs are in three-state. This mechanism must be supplied by the Modbus Master.

The INMBSPAN001I100 device includes an on-board terminator resistor of 120Ω that can be connected to the EIA-485 bus by using DIP-switch SW4 (see below).

Some Modbus RTU EIA-485 Master devices can provide also internal 120Ω terminator resistor and/or fail-safe biasing (check the technical documentation of the Master device connected to the EIA-485 network in each case).

5. Electrical and Mechanical features

Enclosure	Plastic, type PC (UL 94 V-0) Net dimensions (dxwxh): 93 x 53 x 58 mm / 3.7" x 2.1" x 2.3" Color: Light Grey. RAL 7035	Operation Temperature	0°C to +60°C
Weight	85 g.	Stock Temperature	-20°C to +85°C
Mounting	Wall DIN rail EN60715 TH35.	Operational Humidity	<95% RH, non-condensing
Terminal Wiring (for low-voltage signals)	For terminal: solid wires or stranded wires (twisted or with ferrule) 1 core: 0.5mm²... 2.5mm² 2 cores: 0.5mm²... 1.5mm² 3 cores: not permitted	Stock Humidity	<95% RH, non-condensing
Modbus RTU port	1 x Serial EIA485 Plug-in screw terminal block (2 poles) A, B Compatible with Modbus RTU EIA-485 networks	Isolation voltage	1500 VDC
AC unit port	1 x Specific connector Specific cable included	Isolation resistance	1000 MΩ
Switch 1 (SW1)	1 x DIP-Switch for AC features	Protection	IP20 (IEC60529)
Switch 3 (SW3)	1 x DIP-Switch for Modbus RTU settings	LED indicators	1 x Onboard LED - Operational status
Switch 4 (SW4)	1 x DIP-Switch for extra functions		

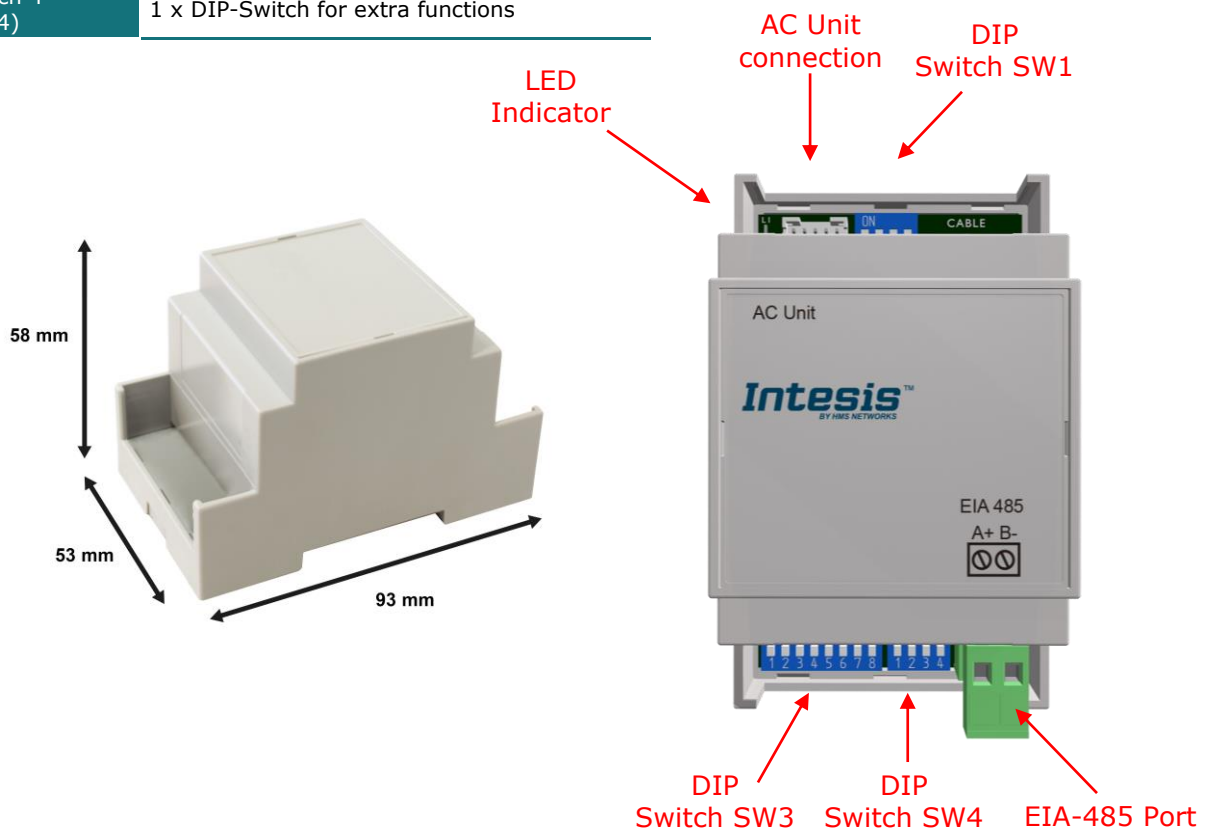

6. List of supported AC Unit Types.

A list of Panasonic indoor unit model's references compatible with INMBSPAN001I100 and its available features can be found on this link:

http://www.intesis.com/docs/compatibilities/inxxspan001ix00_compatibility

7. Error Codes

Error Code Modbus	Error in RC	Abnormality / Protection control	Abnormality Judgment	Problem	Check Location
0	N/A	—	—	No error active	—
65535 (-1)	N/A	—	—	Error in the communication of INMBSPAN001I100 with the AC unit	<ul style="list-style-type: none"> Indoor/gateway connection wire
8209	H11	Indoor/outdoor abnormal communication	After operation for 1 minute	Indoor/outdoor communication not establish	<ul style="list-style-type: none"> Indoor/outdoor wire terminal Indoor/outdoor PCB Indoor/outdoor connection wire
8210	H12	Indoor unit capacity unmatched	90s after power supply	Total indoor capability more than maximum limit or less than minimum limit, or number of indoor unit less than two.	<ul style="list-style-type: none"> Indoor/outdoor connection wire Indoor/outdoor PCB Specification and combination table in catalogue
8212	H14	Indoor intake air temperature sensor abnormality	Continuous for 5s	Indoor intake air temperature sensor open or short circuit	<ul style="list-style-type: none"> Indoor intake air temperature sensor lead wire and connector
8213	H15	Compressor temperature sensor abnormality	Continuous for 5s	Compressor temperature sensor open or short circuit	<ul style="list-style-type: none"> Compressor temperature sensor lead wire and connector
8214	H16	Outdoor current transformer (CT) abnormality	—	Current transformer faulty or compressor faulty	<ul style="list-style-type: none"> Outdoor PCB faulty or compressor faulty
8217	H19	Indoor fan motor mechanism lock	Continuous happen for 7 times	Indoor fan motor lock or feedback abnormal	<ul style="list-style-type: none"> Fan motor lead wire and connector Fan motor lock or block
8227	H23	Indoor heat exchanger temperature sensor abnormality	Continuous for 5s	Indoor heat exchanger temperature sensor open or short circuit	<ul style="list-style-type: none"> Indoor heat exchanger temperature sensor lead wire and connector
8229	H25	Indoor E-Ion abnormality	Port is ON for 10s during E-Ion off	—	<ul style="list-style-type: none"> E-Ion PCB
8231	H27	Outdoor air temperature sensor abnormality	Continuous for 5s	Outdoor air temperature sensor open or short circuit	<ul style="list-style-type: none"> Outdoor air temperature sensor lead wire and connector
8232	H28	Outdoor heat exchanger temperature sensor 1 abnormality	Continuous for 5s	Outdoor heat exchanger temperature sensor 1 open or short circuit	<ul style="list-style-type: none"> Outdoor heat exchanger temperature sensor 1 lead wire and connector
8240	H30	Outdoor discharge pipe temperature sensor abnormality	Continuous for 5s	Outdoor discharge pipe temperature sensor open or short circuit	<ul style="list-style-type: none"> Outdoor discharge pipe temperature sensor lead wire and connector
8242	H32	Outdoor heat exchanger temperature sensor 2 abnormality	Continuous for 5s	Outdoor heat exchanger temperature sensor 2 open or short circuit	<ul style="list-style-type: none"> Outdoor heat exchanger temperature sensor 2 lead wire and connector
8243	H33	Indoor / outdoor misconnection abnormality	—	Indoor and outdoor rated voltage different	<ul style="list-style-type: none"> Indoor and outdoor units check
8244	H34	Outdoor heat sink temperature sensor abnormality	Continuous for 2s	Outdoor heat sink temperature sensor open or short circuit	<ul style="list-style-type: none"> Outdoor heat sink sensor
8246	H36	Outdoor gas pipe temperature sensor abnormality	Continuous for 5s	Outdoor gas pipe temperature sensor open or short circuit	<ul style="list-style-type: none"> Outdoor gas pipe temperature sensor lead wire and connector
8247	H37	Outdoor liquid pipe temperature sensor abnormality	Continuous for 5s	Outdoor liquid pipe temperature sensor open or short circuit	<ul style="list-style-type: none"> Outdoor liquid pipe temperature sensor lead wire and connector
8248	H38	Indoor/Outdoor mismatch (brand code)	—	Brand code not match	<ul style="list-style-type: none"> Check indoor unit and outdoor unit.

8249	H39	Abnormal indoor operating unit or standby units	3 times happen within 40 minutes	Wrong wiring and connecting pipe, expansion valve abnormality, indoor heat exchanger sensor open circuit	<ul style="list-style-type: none"> • Check indoor/outdoor connection wire and connection pipe • Indoor heat exchanger sensor lead wire and connector • Expansion valve and lead wire and connector
8257	H41	Abnormal wiring or piping connection	—	Wrong wiring and connecting pipe, expansion valve abnormality	<ul style="list-style-type: none"> • Check indoor/outdoor connection wire and connection pipe • Expansion valve and lead wire and connector.
8280	H58	Indoor gas sensor abnormality	Continuous for 6 hours	Indoor gas sensor open or short circuit	<ul style="list-style-type: none"> • Indoor gas sensor • Indoor PCB
8281	H59	ECO patrol sensor abnormality	Continuous for 70s	ECO patrol sensor open or short circuit	<ul style="list-style-type: none"> • ECO patrol sensor • ECO patrol and Indoor PCB
8292	H64	Outdoor high pressure sensor abnormality	Continuous for 1 minutes	High pressure sensor open circuit during compressor stop	<ul style="list-style-type: none"> • High pressure sensor • Lead wire and connector
8343	H97	Outdoor fan motor mechanism lock	2 times happen within 30 minutes	Outdoor fan motor lock or feedback abnormal	<ul style="list-style-type: none"> • Outdoor fan motor lead wire and connector • Fan motor lock or block
8344	H98	Indoor high pressure protection	—	Indoor high pressure protection (Heating)	<ul style="list-style-type: none"> • Check indoor heat exchanger • Air filter dirty • Air circulation short circuit
8345	H99	Indoor operating unit freeze protection	—	Indoor freeze protection (Cooling)	<ul style="list-style-type: none"> • Check indoor heat exchanger • Air filter dirty • Air circulation short circuit
12305	F11	4-way valve switching abnormality	4 times happen within 30 minutes	4-way valve switching abnormal	<ul style="list-style-type: none"> • 4-way valve • Lead wire and connector.
12311	F17	Indoor standby units freezing abnormality	3 times happen within 40 minutes	Wrong wiring and connecting pipe, expansion valve leakage, indoor heat exchanger sensor open circuit	<ul style="list-style-type: none"> • Check indoor/outdoor connection wire and pipe • Indoor heat exchanger sensor lead wire and connector • Expansion valve lead wire and connector.
12432	F90	Power factor correction (PFC) circuit protection	4 times happen within 10 minutes	Power factor correction circuit abnormal	<ul style="list-style-type: none"> • Outdoor PCB faulty
12433	F91	Refrigeration cycle abnormality	2 times happen within 20 minutes	Refrigeration cycle abnormal	<ul style="list-style-type: none"> • Insufficient refrigerant or valve close
12435	F93	Compressor abnormal revolution	4 times happen within 20 minutes	Compressor abnormal revolution	<ul style="list-style-type: none"> • Power transistor module faulty or compressor lock
12436	F94	Compressor discharge pressure overshoot protection	4 times happen within 30 minutes	Compressor discharge pressure overshoot	<ul style="list-style-type: none"> • Check refrigeration system
12437	F95	Outdoor cooling high pressure protection	4 times happen within 20 minutes	Cooling high pressure protection	<ul style="list-style-type: none"> • Check refrigeration system • Outdoor air circuit
12438	F96	Power transistor module overheating protection	4 times happen within 30 minutes	Power transistor module overheat	<ul style="list-style-type: none"> • PCB faulty • Outdoor air circuit (fan motor)
12439	F97	Compressor overheating protection	3 times happen within 30 minutes	Compressor overheat	<ul style="list-style-type: none"> • Insufficient refrigerant
12440	F98	Total running current protection	3 times happen within 20 minutes	Total current protection	<ul style="list-style-type: none"> • Check refrigeration system • Power source or compressor lock
12441	F99	Outdoor direct current (DC) peak detection	Continuous happen for 7 times	Power transistor module current protection	<ul style="list-style-type: none"> • Power transistor module faulty or compressor lock

In case to detect an error code not listed, contact your closest Panasonic technical support service.