

General Purpose EMI Filter with High Attenuation Performance



- Rated currents from 1 to 30 A
- High performance filter attenuation
- High differential-mode attenuation
- Optional medical versions (B type)
- Optional safety versions (A type)
- Optional overvoltage protection (Z type)



Performance indicators

Attenuation performance



Approvals



Features and benefits

- FN 2030 filters are designed for easy and fast chassis mounting
- The FN 2030 filters are also available as B versions with no Y-capacitors for medical applications as well as A versions with low capacitance for safety critical applications with a requirement for low leakage currents
- All filters provide an exceptional conducted attenuation performance, based on chokes with high permeable core material and excellent thermal behavior
- The higher inductivity versus amperage offers increased attenuation performance with same form factor compared to FN 2010 and FN 2020 filter series
- All FN 2030 filters can be delivered with optional surge pulse protection. FN 2030 filters are also available as two-stage filters (FN 2090 series) for very noisy environment
- Various terminal options allow you to select the desired connection style

Technical specifications

Operating voltage	110/250 VAC, 50/60 Hz
Operating frequency	dc to 400 Hz
Rated currents	1 to 30 A @ 40°C max.
High potential test voltage	P → PE 2000 VAC for 2 sec (standard types) P → PE 2500 VAC for 2 sec (B types) P → N 1100 VDC for 2 sec
Temperature range (operation and storage)	-25°C to +100°C (25/100/21)
Design corresponding to	UL 1283, CSA 22.2 No. 8 1986, IEC/EN 60939
Flammability corresponding to	UL 94 V-2 or better
Surge pulse protection (optional)	2 kV, IEC 61000-4-5
MTBF @ 40°C/230 V (Mil-HB-217F)	2,200,000 hours (1 to 10 A types) 1,200,000 hours (12 to 30 A types)



Typical application

- Electrical and electronic equipment
- Consumer goods
- Household equipment
- Medical equipment
- Electronic data processing equipment
- Office automation and datacom equipment
- Various noisy applications requiring high filter performance

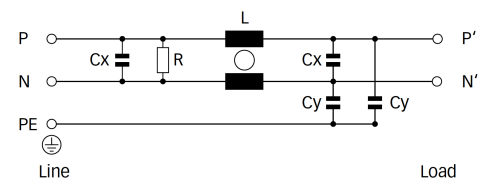
Typical electrical schematic



Filter selection table

Filter*	Rated current	Leakage current**	Inductance	Capacitance		Resistance	Input/Output connections			Weight
	@ 40°C (25°C)			@ 230 VAC/50 Hz	L		Cx	Cy	R	
	[A]	[mA]	[mH]	[μF]	[nF]	[kΩ]				[g]
FN 2030-1-..	1 (1.1)	0.34	20	0.22	2.2	1000	-06	-07		58
FN 2030-3-..	3 (3.4)	0.52	14	0.33	3.3	1000	-06	-07		87
FN 2030-4-..	4 (4.5)	0.52	14	0.33	3.3	1000	-06	-07		92
FN 2030-6-..	6 (6.7)	0.73	8	0.47	4.7	680	-06	-07		100
FN 2030-8-..	8 (8.9)	0.73	8	0.47	4.7	680	-06	-07		170
FN 2030-10-..	10 (11.2)	0.73	8	0.47	4.7	680	-06	-07		196
FN 2030-12-..	12 (13.4)	0.87	4	1.0	10	330	-06	-07		185
FN 2030-16-..	16 (17.9)	0.87	4	1.0	10	330	-06	-07		225
FN 2030-20-..	20 (22.4)	0.87	4	1.0	10	330	-06		-08	285
FN 2030-30-08	30 (33.5)	0.87	2	1.0	10	330			-08	326
FN 2030A-1-..	1 (1.1)	0.074	20	0.22	0.47	1000	-06	-07		58
FN 2030A-3-..	3 (3.4)	0.074	14	0.33	0.47	1000	-06	-07		87
FN 2030A-4-..	4 (4.5)	0.074	14	0.33	0.47	1000	-06	-07		92
FN 2030A-6-..	6 (6.7)	0.074	8	0.47	0.47	680	-06	-07		100
FN 2030A-8-..	8 (8.9)	0.074	8	0.47	0.47	680	-06	-07		170
FN 2030A-10-..	10 (11.2)	0.074	8	0.47	0.47	680	-06	-07		196
FN 2030A-12-..	12 (13.4)	0.074	4	1.0	0.47	330	-06	-07		185
FN 2030A-16-..	16 (17.9)	0.074	4	1.0	0.47	330	-06	-07		225
FN 2030A-20-..	20 (22.4)	0.074	4	1.0	0.47	330	-06		-08	285
FN 2030A-30-08	30 (33.5)	0.074	2	1.0	0.47	330			-08	326
FN 2030B-1-..	1 (1.1)	0.002	20	0.22		1000	-06	-07		58
FN 2030B-3-..	3 (3.4)	0.002	14	0.33		1000	-06	-07		87
FN 2030B-4-..	4 (4.5)	0.002	14	0.33		1000	-06	-07		92
FN 2030B-6-..	6 (6.7)	0.002	8	0.47		680	-06	-07		100
FN 2030B-8-..	8 (8.9)	0.002	8	0.47		680	-06	-07		170
FN 2030B-10-..	10 (11.2)	0.002	8.45	0.47		680	-06	-07		196
FN 2030B-12-..	12 (13.4)	0.002	4	1.0		330	-06	-07		185
FN 2030B-16-..	16 (17.9)	0.002	4	1.0		330	-06	-07		225
FN 2030B-20-..	20 (22.4)	0.002	4	1.0		330	-06		-08	285
FN 2030B-30-08	30 (33.5)	0.002	2	1.0		330			-08	326

* To compile a complete part number, please replace the .. with the required I/O connection style. For surge pulse protection, please add Z (e.g. FN 2030Z-10-06, FN 2030BZ-20-08).
 ** Maximum leakage under normal operating conditions. Note: if the neutral line is interrupted, worst case leakage could reach twice this level.

Typical filter attenuation

Per CISPR 17; A=50 Ω/50 Ω sym; B=50 Ω/50 Ω asym; C=0.1 Ω/100 Ω sym; D=100 Ω/0.1 Ω sym

1 to 4 A types

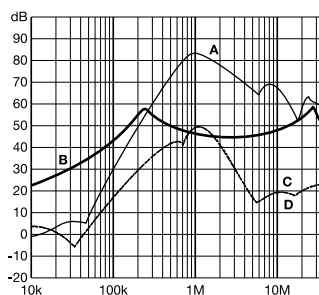

6 to 10 A types

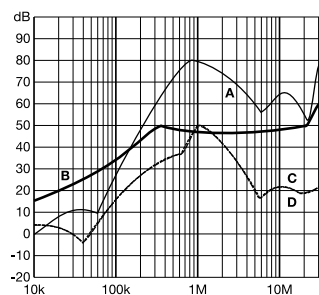

12 to 20 A types

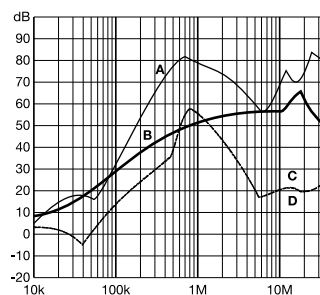

30 A types

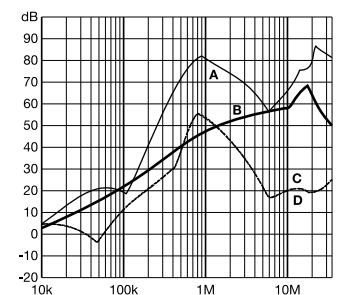

Mechanical data

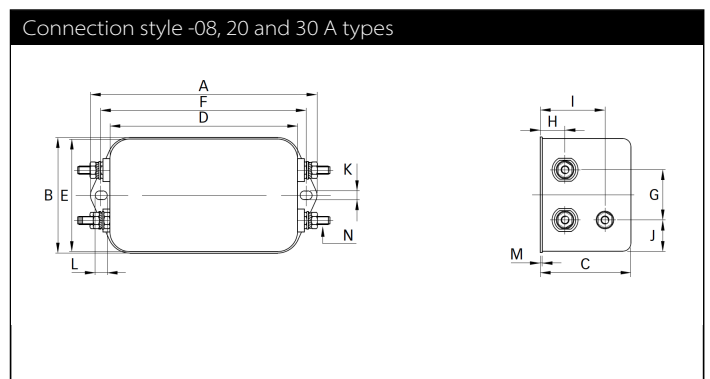
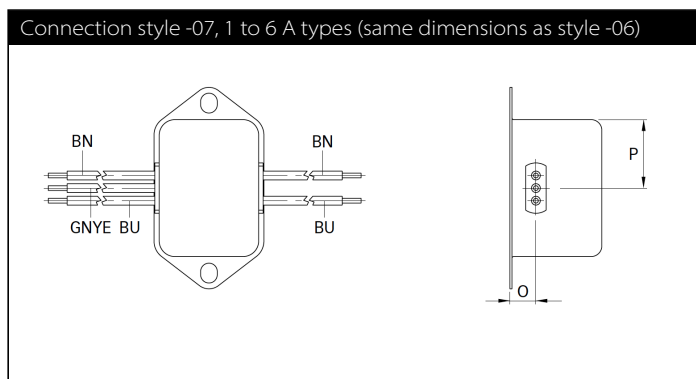
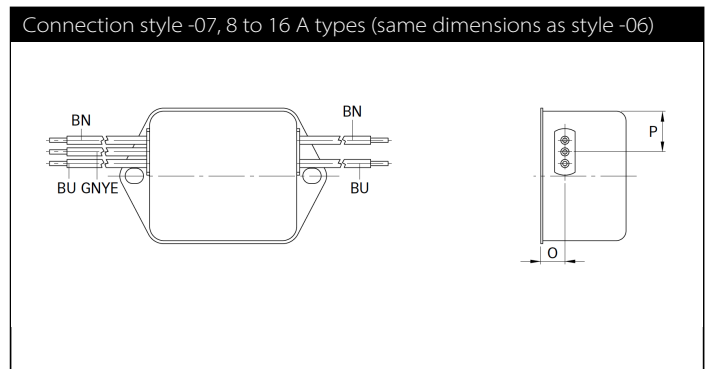
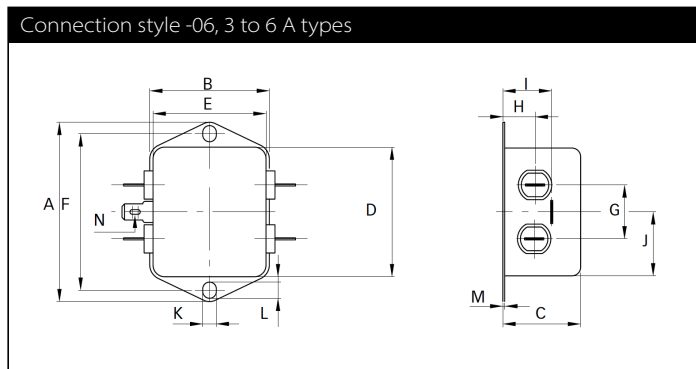
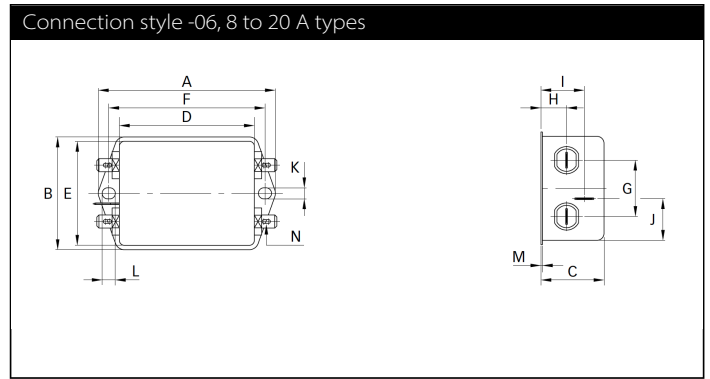
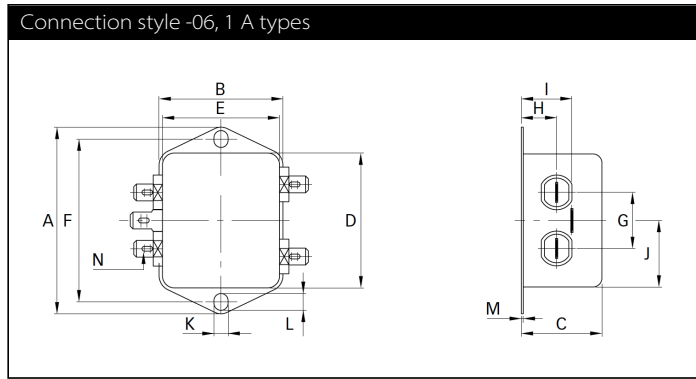

Dimensions

	1 A	3 A	4 A	6 A	8 A	10 A	12 A	16 A	20 A	30 A	Tolerances
A	64	71	71	71	85	85	85	85	85	85	±0.5
B	35	46.6	46.6	46.6	54	54	54	54	54	54	±0.5
C	24.3	22.3	22.3	22.3	30.3	30.3	30.3	40.3	40.3	40.3	±0.5
D	43.5	50.5	50.5	50.5	64.8	64.8	64.8	64.8	64.8	64.8	±0.5
E	32.5	44.5	44.5	44.5	49.8	49.8	49.8	49.8	49.8	49.8	±0.5
F	54	61	61	61	75	75	75	75	75	75	±0.3
G	21	21	21	21	27	27	27	27	27	27	±0.2
H	9.3	10.8	10.8	10.8	12.3	12.3	12.3	12.3	12.3	12.3	±0.5
I	15.3	16.8	16.8	16.8	20.8	20.8	20.8	29.8	29.8	29.8	±0.5
J	21.8	25.25	25.25	25.25	19.9	19.9	19.9	11.4	11.4	11.4	±0.5
K	5.3	5.3	5.3	5.3	5.3	5.3	5.3	5.3	5.3	5.3	
L	6.3	6.3	6.3	6.3	6.3	6.3	6.3	6.3	6.3	6.3	
M	0.7	0.7	0.7	0.7	0.7	0.7	0.7	0.7	0.7	0.7	
Connection style -06											
N	6.3 x 0.8	6.3 x 0.8	6.3 x 0.8	6.3 x 0.8	6.3 x 0.8	6.3 x 0.8	6.3 x 0.8	6.3 x 0.8	6.3 x 0.8	6.3 x 0.8	
Connection style -07											
O	8.3	8.3	8.3	8.3	8.3	8.3	8.3	8.3	8.3		±0.5
P	21.8	14	14	14	14.9	14.9	14.9	14.9			±0.5
AWG type wire	AWG 20	AWG 20	AWG 20	AWG 18	AWG 18	AWG 18	AWG 16	AWG 16			
Wire length	140	140	140	140	140	140	140	140			
Connection style -08											
N									M4	M4	

All dimensions in mm; 1 inch = 25.4 mm
Tolerances according: ISO 2768-m/EN 22768-m



Headquarters, global innovation and development center

Switzerland

Schaffner Group

Nordstrasse 11
4542 Luterbach
T +41 32 6816 626
F +41 32 6816 630
info@schaffner.com
<http://www.schaffner.com>



Sales and application centers

China

Schaffner EMC Ltd. Shanghai

T20-3, No 565 Chuangye Road
Pudong New Area
201201 Shanghai
T +86 21 3813 9500
F +86 21 3813 9501 / 02
cschina@schaffner.com
<http://www.schaffner.com.cn/>

Finland

Schaffner Oy

Sauvonrinne 19 H
08500 Lohja
T +358 19 35 72 71
finlandsales@schaffner.com

France

Schaffner EMC S.A.S.

112 Quai de Bezons
Boîte postale 133
95100 Argenteuil
T +33 1 34 34 30 60
F +33 1 39 47 02 28
francesales@schaffner.com

Germany

Schaffner Deutschland GmbH

Schoemperlenstrasse 12B
76185 Karlsruhe
T +49 721 56910
F +49 721 569110
germanysales@schaffner.com

Italy

Schaffner EMC S.r.l.

Via Galileo Galilei 47
20092 Cinisello Balsamo (MI)
T +39 02 66 04 30 45 /47
F +39 02 61 23 943
italysales@schaffner.com

Japan

Schaffner EMC K.K.

1-32-12, Kamiyama, Setagaya-ku
7F Mitsui-seimei Sangenjaya Bldg.
154-0011 Tokyo
T +81 3 5712 3650
F +81 3 5712 3651
japansales@schaffner.com
<http://www.schaffner.jp>

Spain

Schaffner EMC España

Calle Caléndula 93, Miniparc III, Edificio E,
Alcobendas
Miniparc III, Edificio E
El Soto de la Moraleja
Alcobendas
28109 Madrid
M +34 618 176 133
T +34 917 912 900
F +34 917 912 901
spainsales@schaffner.com

Sweden

Schaffner EMC AB

Turebergstorg 1, 6
19147 Sollentuna
T +46 8 5792 1121 / 22
F +46 8 92 96 90
swedensales@schaffner.com

Switzerland

Schaffner EMV AG

Nordstrasse 11
4542 Luterbach
T +41 32 681 66 26
F +41 32 681 66 41
switzerlandsales@schaffner.com

Taiwan R.O.C.

Schaffner EMV Ltd.

6 Floor, No. 413
114 Neihu District Taipei City
T +886 2 87525050
F +886 2 87518086
taiwansales@schaffner.com

Thailand

Schaffner EMC Co. Ltd.

Northern Region Industrial Estate
67 Moo 4 Tambon Ban Klang
Amphur Muangng P.O. Box 14
51000 Lamphun
T +66 53 58 11 04
F +66 53 58 10 19
thailandsales@schaffner.com

UK

Schaffner Ltd.

Wokingham
RG41 2PL Berkshire
T +44 118 9770070
F +44 118 9792969
uksales@schaffner.com
<http://www.schaffner.com>

USA

Schaffner EMC Inc.

52 Mayfield Avenue
08837 Edison, New Jersey
T +1 800 367 5566
T +1 732 225 9533
F +1 732 225 4789
usasales@schaffner.com
www.schaffnerusa.com

Schaffner North America

6722 Thirlane Road
24019 Roanoke, Virginia
T +1 276 228 7943
F +1 276 228 7953
www.schaffnerusa.com

Schaffner North America

823 Fairview Road
24382 Wytheville, Virginia
T +1 276 228 7943
F +1 276 228 7258
www.schaffnerusa.com

To find your local partner within Schaffner's global network: www.schaffner.com

© 2016 Schaffner Group

The content of this document has been carefully checked and understood. However, neither Schaffner nor its subsidiaries assume any liability whatsoever for any errors or inaccuracies of this document and the consequences thereof. Published specifications are subject to change without notice. Product suitability for any area of application must ultimately be determined by the customer. In all cases, products must never be operated outside their published specifications. Schaffner does not guarantee the availability of all published products. This disclaimer shall be governed by substantive Swiss law and resulting disputes shall be settled by the courts at the place of business of Schaffner Holding AG. Latest publications and a complete disclaimer can be downloaded from the Schaffner website. All trademarks recognized.

Mouser Electronics

Authorized Distributor

Click to View Pricing, Inventory, Delivery & Lifecycle Information:

Schaffner:

[FN2030BZ-6-06](#) [FN2030-1-07](#) [FN2030-3-07](#) [FN2030-4-07](#) [FN2030-6-07](#) [FN2030-8-07](#) [FN2030-10-07](#) [FN2030-12-07](#) [FN2030-16-07](#) [FN2030-20-07](#) [FN2030-20-08](#) [FN2030Z-1-06](#) [FN2030Z-3-06](#) [FN2030Z-4-06](#) [FN2030Z-6-06](#) [FN2030Z-8-06](#) [FN2030Z-10-06](#) [FN2030Z-12-06](#) [FN2030Z-16-06](#) [FN2030Z-20-06](#) [FN2030Z-30-08](#) [FN2030BZ-1-06](#) [FN2030BZ-3-06](#) [FN2030BZ-4-06](#) [FN2030BZ-8-06](#) [FN2030BZ-10-06](#) [FN2030BZ-12-06](#) [FN2030BZ-16-06](#) [FN2030BZ-20-06](#) [FN2030BZ-30-08](#)