

ENGINEERING DEPT.		PRODUCT SPECIFICATION For CP35 Series Power Connector	SPEC.NO.:	SPCP008L
REVISIONS	ECN13008-0		PAGE:	1/6

1. SCOPE:

This specification contains the test requirement of subject connectors when tested under the condition and procedure with terminals crimped on the specified maximum size wire

2. APPLICABLE STANDARDS:

MIL - STD - 202	Methods for test of connectors for electronic equipment
MIL - STD - 1344	Test methods for electrical connectors
J-STD-020	Resistance to soldering Temperature for through hole Mounted Devices
SS-00254	Test methods for electronic components ,LEAD-FREE soldering Part design standards

3. APPLICABLE SERIES NO.: CP35 Series

4. SHAPE, CONSTRUCTION AND DIMENSIONS

See attached drawings

5. MATERIALS

See attached drawings

6. ACCOMMODATED P.C.BOARD

6.1 Thickness: 1.6 mm (.063")

6.2 P.C. Board Layout: See attached drawings



REVIEWED : David APPROVED : Eisley VERIFIED : Steven .

ENGINEERING DEPT.		PRODUCT SPECIFICATION For CP35 Series Power Connector	SPEC.NO.:	SPCP008L
REVISIONS	ECN13008-0		PAGE:	2/6

7. ELECTRICAL PERFORMANCE:

	ITEM	TEST CONDITION	REQUIREMENT			
7.1	Rated voltage(max.)		600V AC (r.m.s.)			
	Rated Current(max.) and Applicable Wire (Wire-to-Board)	Circuits/Wire gage	2	4-6	8-12	14-24
		AWG#20 wire gage	7.0A	5.5A	5.0A	4.5A
		AWG#22 wire gage	6.0A	4.5A	4.0A	3.5A
		AWG#24 wire gage	5.5A	4.5A	3.5A	3.0A
		AWG#26 wire gage	4.5A	4.0A	3.5A	2.5A
		AWG#28 wire gage	4.0A	3.0A	3.0A	2.0A
		AWG#30 wire gage	3.5A	3.0A	2.5A	1.0A
	Rated Current(max.) and Applicable Wire (Wire-to-Wire)	Circuits/Wire gage	2	4-6	8-12	14-24
		AWG#20 wire gage	6.5A	5.0A	4.5A	4.0A
		AWG#22 wire gage	5.5A	4.0A	3.5A	3.0A
		AWG#24 wire gage	5.0A	4.0A	3.0A	2.0A
		AWG#26 wire gage	4.0A	3.0A	2.5A	1.5A
		AWG#28 wire gage	3.0A	2.0A	2.0A	1.0A
		AWG#30 wire gage	3.0A	2.0A	2.0A	1.0A
7.2	Contact resistance	Dry circuit of DC 20mV max. , 100mA max., Wire resistance shall be removed from the measured value.	Less than 10 mΩ			
7.3	Dielectric strength	When applied AC 1500 V 1 minute between adjacent terminal	No Breakdown			
7.4	Insulation resistance	When applied DC 500 V between adjacent terminal or ground	More than 1000 MΩ			
7.5	Contact resistance on Crimped portion	Crimp the wire to the terminal, measure by dry circuit, 20mV max., 100mA max., Wire resistance shall be removed from the measured value.	Less than 5 mΩ			

8. MECHANICAL PERFORMANCE:

	ITEM	TEST CONDITION	REQUIREMENT
8.1	Wire size	Specified wire size	Accepts AWG #20-#30

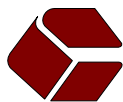

ENGINEERING DEPT.		PRODUCT SPECIFICATION For CP35 Series Power Connector	SPEC.NO.:	SPCP008L
REVISIONS	ECN13008-0		PAGE:	3/6

	ITEM	TEST CONDITION	REQUIREMENT
8.2	Terminal crimp strength	When crimped AWG#20 size wire	More than 7.0 Kgf
		When crimped AWG#22 size wire	More than 5.0 Kgf
		When crimped AWG#24 size wire	More than 3.0 Kgf
		When crimped AWG#26 size wire	More than 2.0 Kgf
		When crimped AWG#28 size wire	More than 1.2 Kgf
		When crimped AWG#30 size wire	More than 0.8 Kgf
8.3	Terminal insertion force	Insertion speed 25± 3 mm per minute into housing	Less than 1.5 Kgf
8.4	Terminal retaining force in insulator	Retention speed 25± 3 mm per minute from Wire to Wire Housing	More than 3.0 Kgf
8.5	Single contact insertion force	Measure force to insertion using mating square pin at speed 25± 3 mm per minute	700 gram max.
8.6	Single contact withdrawal force	Measure force to withdrawal using mating square pin at speed 25± 3 mm per minute	150 gram min.
8.7	Pin retention force in Board mount Header	Push Pin for insulator base at speed 25± 3 mm per minute	More than 1.5 Kgf
8.8	Durability	Connector shall be subjected to 30 cycles of insertion and withdrawal	Contact resistance: Less than twice of initial
8.9	Locking force	While with drawing plug&receptacle without terminal at speed 25± 3 mm per minute	More than 5.5 Kgf

8.10 Insertion Force and Withdrawal Force :

8.10.1 Test method:

Housing with crimped contacts and a header shall be mated and unmated on the same axis. Initial insertion and withdrawal forces and withdrawal force at 30th shall be measured for single circuit and multi-circuits. For the measurement of single circuit, the housing lock shall be removed.

ENGINEERING DEPT.		PRODUCT SPECIFICATION For CP35 Series Power Connector	SPEC.NO.:	SPCP008L
REVISIONS	ECN13008-0		PAGE:	4/6

8.10.2 Requirements:
Unit: Kgf

NO. OF CIRCUITS	INSERTION FORCE Max.)	WITHDRAWAL FORCE (Min.)
2	2.0	0.5
4	3.0	1.0
6	6.0	1.5
8	7.0	2.0
10	9.0	2.5
12	10.0	3.0
14	11.0	3.5
16	12.0	4.0
18	13.0	4.5
20	14.0	5.0
22	15.0	5.5
24	16.0	6.0

9. ENVIRONMENTAL PERFORMANCE:

	ITEM	TEST CONDITION	REQUIREMENT
9.1	Temperature rise	Then carried the rated current	30°C max.
9.2	Vibration	1.5 mm 10-55-10 HZ/minute each 2 hours for X, Y and Z directions	Appearance: No damage Discontinuity: 1 micro second max.
9.3	Heat aging	105± 2°C, 96 hours	No damage
9.4	Humidity	60± 2°C, 90-95% RH, 96 hours measurement must be taken within 30 min. after tested	Appearance: No damage Contact resistance: Less than twice of initial Dielectric strength: To pass para 7-3
9.5	Temperature cycling	One cycle consists of : (1) -55 +0/-3 °C , 30 min. (2) Room temp. 10-15 min. (3) 105 +3/-0 °C , 30 min. (4) Room temp. 10-15 min.	Appearance: No damage Contact resistance: Less than twice of initial



ENGINEERING DEPT.		PRODUCT SPECIFICATION For CP35 Series Power Connector	SPEC.NO.:	SPCP008L
REVISIONS	ECN13008-0		PAGE:	5/6

	ITEM	TEST CONDITION	REQUIREMENT
9.6	Salt spray	Temperature: 35± 3°C Solution: 5± 1% Spray time: 48± 4 hours Measurement must be taken after water rinse	Appearance: No damage Contact resistance: Less than twice of initial
9.7	Solder ability	Tin-Lead Process: Soldering time: 5 ± 0.5 second Soldering pot: 230 ± 5°C Lead-Free Process: Soldering time: 3 ± 0.5 second Soldering pot: 245 ± 5°C	Minimum: 90% of immersed area
9.8	Resistance to soldering heat	DIP Type Tin-Lead Process: Soldering time: 5 ± 0.5 second Soldering pot: 240 ± 5°C DIP Type Lead-Free Process Soldering time: 5 ± 0.5 second Soldering pot: 260 ± 5°C SMT Type Tin-Lead Process: Refer Reflow temperature profile(11.1) Soldering time: 10 second Max. Soldering pot: 230 ± 5 °C SMT Type Lead-Free Process: Soldering time: 20 second Max. Soldering pot: 250~260°C Refer Reflow temperature profile(11.2)	No damage

10. AMBIENT TEMPERATURE RANGE: -40 to + 105°C

ENGINEERING DEPT.		PRODUCT SPECIFICATION For CP35 Series Power Connector	SPEC.NO.:	SPCP008L
REVISIONS	ECN13008-0		PAGE:	6/6

11. Recommended IR Reflow Temperature Profile:

11.1 Using Typical Solder Paste

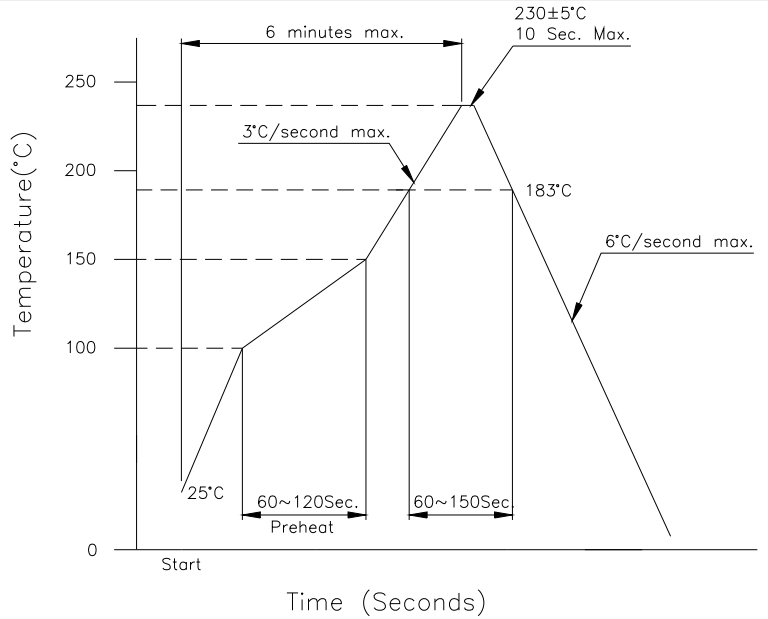

11.2 Using Lead-Free Solder Paste

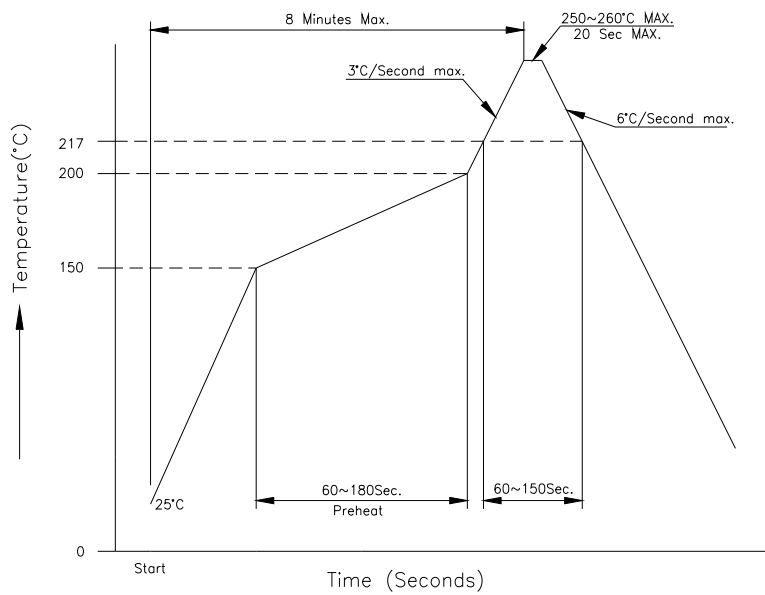

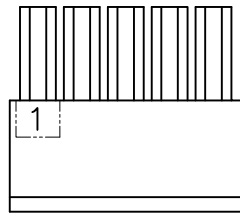
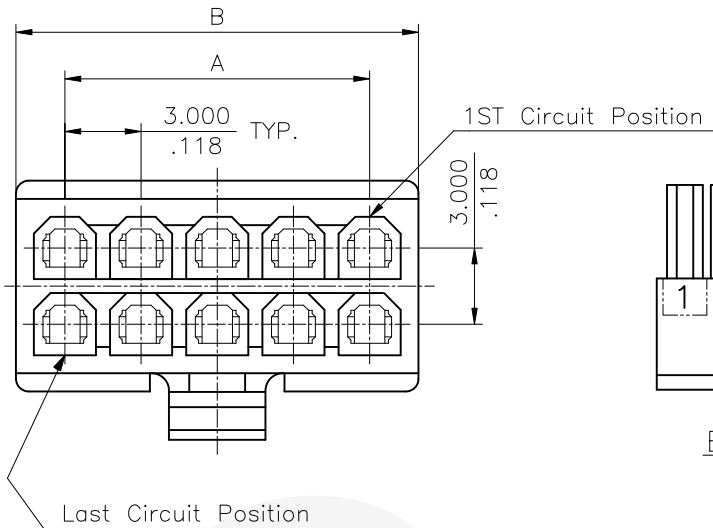

BACK VIEW

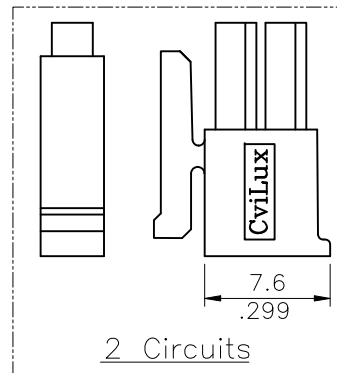

2 Circuits

Material: Nylon 66 UL 94V-0

Ordering Code:

CP35 ** S 001 0 -NH
 ① ② ③ ④ ⑤ ⑥

- ① Series No.
- ② Connector:
- ③ Contact type: S = Receptacle
- ④ Color: 001 = Color Black
- ⑤ Option: 0 = Standard
- ⚠️ ⑥ -NH= Halogen-Free

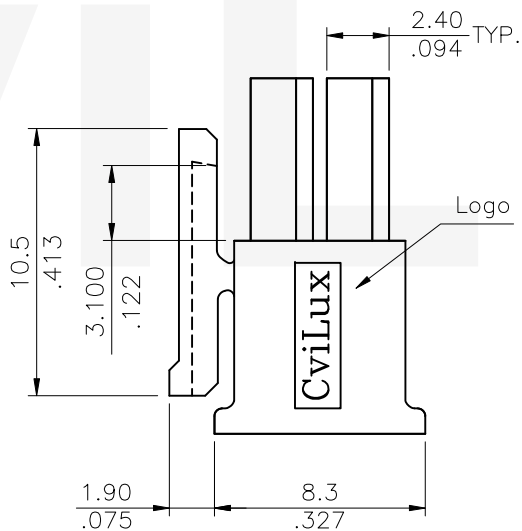
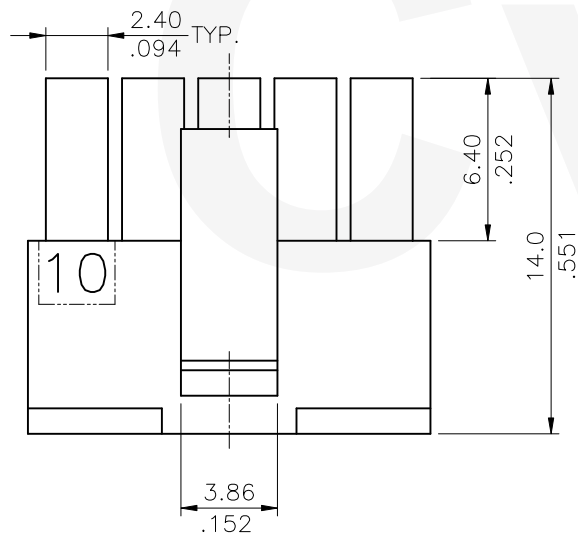

Circuits	Dimension	
	A	B
2	—	3.9(.154)
4	3.00(.118)	6.9(.272)
6	6.00(.236)	9.9(.390)
8	9.00(.354)	12.9(.508)
10	12.00(.472)	15.9(.626)
12	15.00(.591)	18.9(.744)
14	18.00(.709)	21.9(.862)
16	21.00(.827)	24.9(.980)
18	24.00(.945)	27.9(1.098)
20	27.00(1.063)	30.9(1.217)
22	30.00(1.181)	33.9(1.335)
24	33.00(1.299)	36.9(1.453)

Halogen-Free

RoHS Compliant

④					DATE	UNIT: mm / inch	TITLE: 3.00mm PITCH POWER CONNECTOR FEMALE HOUSING
③					DRAWN BY: Sandy	6/11-19'	MATERIAL:
②					ENGINEER: Sun	6/19-19'	
①	Sandy	6/11-19'	ECNT119143		CHECKED BY: Eisley	7/04-19'	CUSTOMER: HL0142 F5T0051
SYM	NAME	DATE	REVISIONS		APPROVED BY: Eisley	7/04-19'	

CIVILUX CORP
 2019.07.05
 ISSUED



瀚荃股份有限公司
 CviLux Corporation

DRAWING NO.	CP3589SB	PART NO.	CP35**S0010-NH
SCALE	3 / 1	SHEET	1 OF 1