

**SILICON RECTIFIER**

**VOLTAGE RANGE 50 to 1000 Volts CURRENT 1.0 Ampere**

**FEATURES**

- \* Low cost
- \* Low leakage
- \* Low forward voltage drop
- \* High current capability

**MECHANICAL DATA**

- \* Case: Molded plastic
- \* Epoxy: Device has UL flammability classification 94V-O
- \* Lead: MIL-STD-202E method 208C guaranteed
- \* Mounting position: Any
- \* Weight: 0.33 gram

**MAXIMUM RATINGS AND ELECTRICAL CHARACTERISTICS**

Ratings at 25 °C ambient temperature unless otherwise specified.  
 Single phase, half wave, 60 Hz, resistive or inductive load.  
 For capacitive load, derate current by 20%.

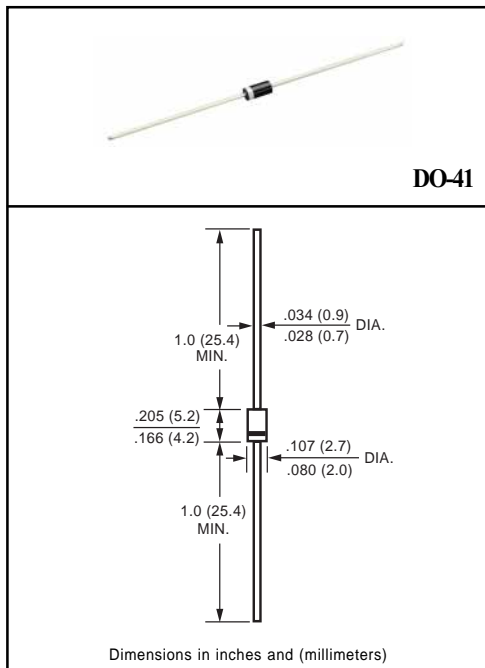

**MAXIMUM RATINGS** (At TA = 25°C unless otherwise noted)

RATINGS	SYMBOL	1N4001	1N4002	1N4003	1N4004	1N4005	1N4006	1N4007	UNITS
Maximum Recurrent Peak Reverse Voltage	VRRM	50	100	200	400	600	800	1000	Volts
Maximum RMS Voltage	VRMS	35	70	140	280	420	560	700	Volts
Maximum DC Blocking Voltage	Vdc	50	100	200	400	600	800	1000	Volts
Maximum Average Forward Rectified Current at TA = 75°C	Io	1.0							Amps
Peak Forward Surge Current 8.3 ms single half sine-wave superimposed on rated load (JEDEC method)	IFSM	30							Amps
Typical Junction Capacitance (Note)	CJ	15							pF
Typical Thermal Resistance	R θ JA	50							°C/W
Operating and Storage Temperature Range	TJ, TSTG	-65 to + 175							°C

**ELECTRICAL CHARACTERISTICS** (At TA = 25°C unless otherwise noted)

CHARACTERISTICS	SYMBOL	1N4001	1N4002	1N4003	1N4004	1N4005	1N4006	1N4007	UNITS
Maximum Instantaneous Forward Voltage at 1.0A DC	VF	1.1							Volts
Maximum DC Reverse Current at Rated DC Blocking Voltage	@ TA = 25°C	5.0							uAmps
	@ TA = 100°C	50							
Maximum Full Load Reverse Current Average, Full Cycle .375" (9.5mm) lead length at TL = 75°C	IR	30							uAmps

NOTES : Measured at 1 MHz and applied reverse voltage of 4.0 volts

# RATING AND CHARACTERISTIC CURVES ( 1N4001 THRU 1N4007 )

FIG. 1 - TYPICAL FORWARD CURRENT DERATING CURVE

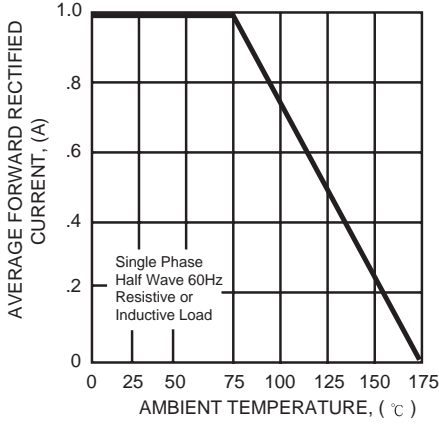

FIG. 2 - TYPICAL INSTANTANEOUS FORWARD CHARACTERISTICS

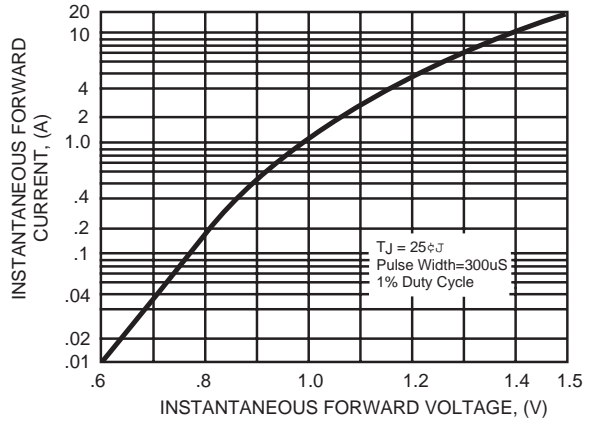

FIG. 3 - MAXIMUM NON-REPETITIVE FORWARD SURGE CURRENT

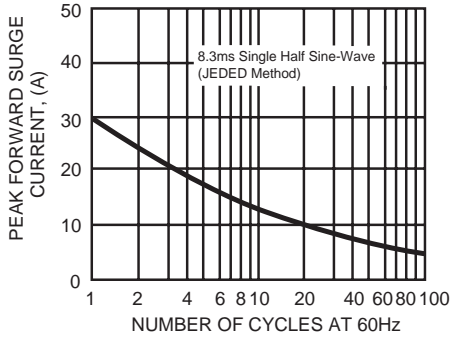

FIG. 4 - TYPICAL REVERSE CHARACTERISTICS

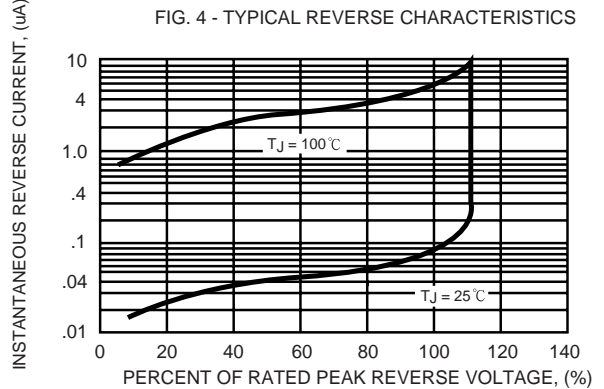

FIG. 5 - TYPICAL JUNCTION CAPACITANCE

